



شركة التخطيط الحديث للمقاولات
Modern Planning Contracting Co.

COMPANY PROFILE

www.mpcos-a.com



ABOUT US

The first step:

The new market high demand in all sectors, especially the construction field, and market curing from old tough circumstances, motivated us to establish Modern Planning Contracting Company in January 2021, (MPCO), that aims to serve several sectors and to be part of this ambitious market, and add a finger print in the prestigious projects that Kingdome of Saudi Arabia launched recently.

Led by its ambition, MPCO started the building of its own team and went into discussions and generated several agreements with partners from local & international market to serve the civil works & general constructions, steel structures work, aluminum, facades, curtain walls & wood works.

Long term experience of the MPCO staff will lead to execute all types of works as per local and international standards satisfying the client's needs and demands.



The first leap 2024:

The big demand of steel structure works, and the becoming true dreams of the 2030 Saudi Vision Projects enthusiast us turn them all steel workshop we had before to become our subsidiary company MODERN PLANNING STEEL INDUSTRIES, with a dedicated engineering staff, skilled workers to serve the construction sector.

Our new factory located in Riyadh, the Gate Industrial Area-New Al Kharj Road, with 1600m² area, filled with variety of conventional, NC & CNC machines.

MPCO is willing to invest more in its factory to cover all needs of the industry.



VISION

Aims to take place and be part of the fast-developing market, taking the lead in prestigious projects in the future, being a company of choice as a preferred contractor to the clients

VISION AND MISSION

MISSION

Building TRUST, providing the best workmanship quality with the highest level of professionalism and business ethics, fulfilling all the needs and demands required reaching the best results for all, clients, vendors & our team.

COMPANY VALUES & DNA

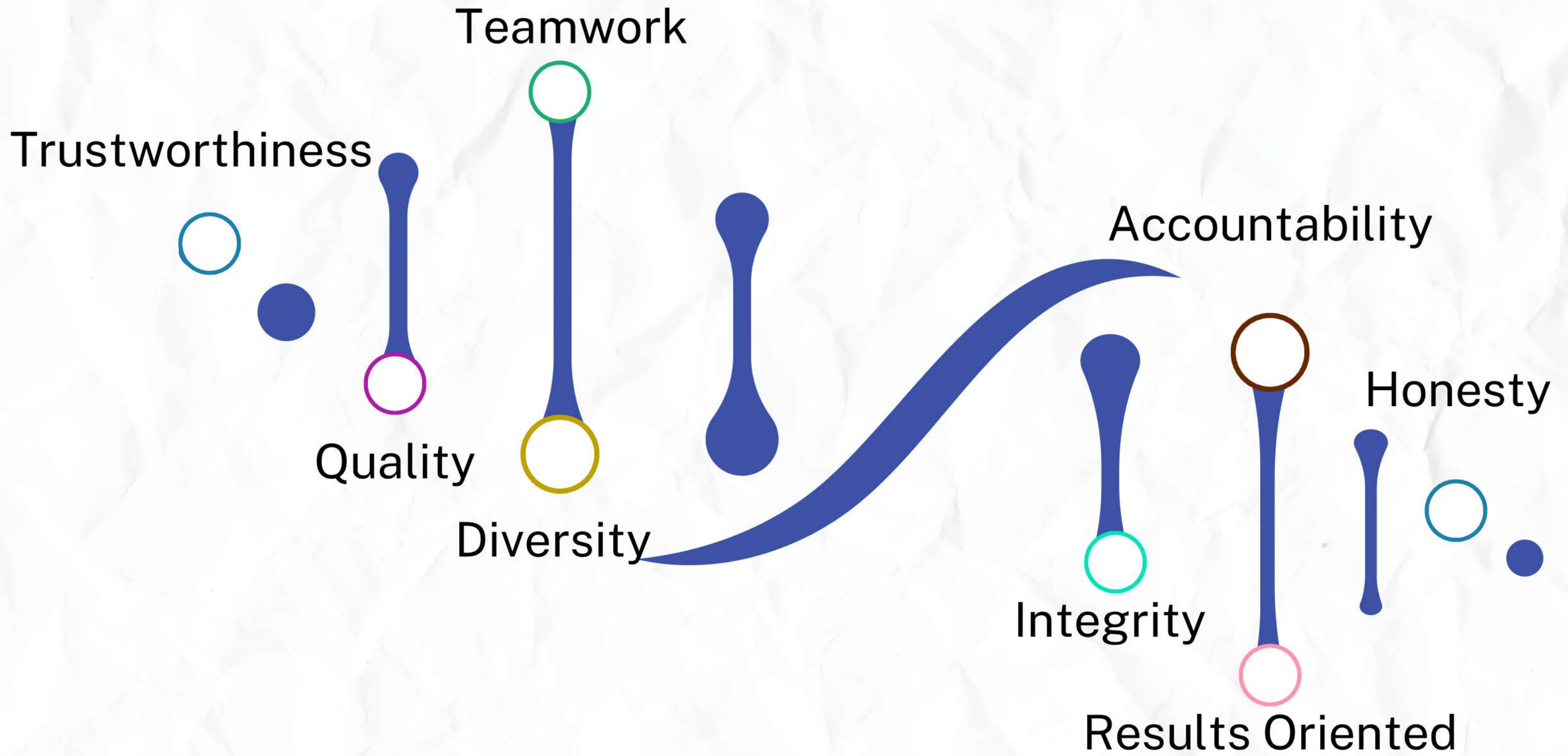

ORGANIZATION CHART



 **CEO**

Secretary

Finance Dept.

Procurement Dept.

Marketing Dept.

Engineering Dept.

Production Dept.

Logistics

Finance Mgr.

Procurement Mgr.

Marketing Mgr.

Engineering Mgr.

Production Mgr.

Installation dept

Finance Team

Procurement Team

Sales Team

Marketing Team

Engineering Team

Production Team

Installation Team

LEGAL DOCUMENTS



الرقم الموحد : ٧.٢١٢٥٣٤٢٧
رقم المنشأة : ١٠١٠٦٨١٤١١
التاريخ : ١٤٤٢/٠٦/٠٥ هـ

شهادة تسجيل فرع شركة Branch Of Company Registration Certificate



الاسم التجاري للشركة : شركة جبل القلعة للمقاولات
نوعها : ذات مسؤولية محدودة
مركزها الرئيسي : 0000 الرياض 00000
هاتف :
الرمز البريدي :
ص.ب :
رقم سجل المركز الرئيسي : ١٠١٠٢٧٩٧٤٨
تاريخه : ١٤٣١/٠١/٢٦ هـ
مصدره : الرياض
الاسم التجاري : شركة التخطيط الحديث للمقاولات شركة شخص واحد (شخص واحد)
العنوان : ٨٥٣٠، شارع ابي بكر الصديق، المرسلات ، ٣٨٣٣
هاتف :
الرمز البريدي : ١٢٤٦٤
ص.ب :
النشاط : للاطلاع على بيانات الأنشطة الرجاء مسح الرمز التجاري
ملكية الشركة : مختلطة
اسم المدير (رباعيا) : زيد رجي ابراهيم ابو نصير
الجنسية : أردني
تاريخ الميلاد : ١٣٩٧ هـ
مكان الميلاد :
رقم السجل المدني : ٢٣٢٩٥٨٨٤٠٠
تاريخه :
مصدره :
سلطات المدير : حسب ما نص عليه عقد الشركة
تاريخه :
مصدره :
يشهد مكتب السجل التجاري بمدينة : الرياض
بأنه تم تسجيل فرع الشركة المذكورة أعلاه بمدينة : الرياض
وتنتهي صلاحية الشهادات في : ١٤٤٧/٠٦/٠٥ هـ
بموجب الإيصال رقم : ٢٥١١٨٠٢٣
وتاريخ : ١٤٤٥/٠٦/١٢ هـ



To Verify The Information Of This Certificate Visit <http://mp.mc.gov.sa> يمكنكم التحقق من صحة هذه الشهادة بالدخول على

+966 11 294 4444 | Riyadh 11162 الرياض | Kingdom of Saudi Arabia | المملكة العربية السعودية | www.mc.gov.sa MCgovSA @ f t d

LEGAL DOCUMENTS



100241101280909

TIN 3112278034 الرقم المميز
Certificate No. 100241101280909 رقم الشهادة
Certificate date 28/03/2022 تاريخ الشهادة

هيئة الزكاة والضريبة والجمارك
Zakat, Tax and Customs Authority
المملكة العربية السعودية
Kingdom of Saudi Arabia

شهادة تسجيل في ضريبة القيمة المضافة VAT Registration Certificate

تشهد هيئة الزكاة والضريبة والجمارك بأن المكلف أدناه مسجل في ضريبة القيمة المضافة بتاريخ ٢٨/٠٣/٢٠٢٢ م
The Zakat, Tax and Customs Authority certifies that taxpayer below is VAT registered on 28/03/2022 AD

Taxpayer Name	شركة جبل القلعة للمقاولات	اسم المكلف
VAT Registration Number	311227803400003	رقم التسجيل الضريبي
Effective Registration Date	2022/03/01	تاريخ نفاذ التسجيل
Taxpayer Address	الرياض، حي اليرموك، البرقا، 13251	عنوان المكلف
CR / License Contact / ID No	1010279748	رقم السجل التجاري / الرخصة / العقد / الهوية
Tax Period	ربع سنوي - Quarterly	الفترة الضريبية
First Filing due date	2022/04/30	تاريخ استحقاق أول إقرار ضريبي

ملاحظة: كمشغلين مسجلين في ضريبة القيمة المضافة، لا يجوز لكم تحصيل ضريبة القيمة المضافة من عملائكم قبل تاريخ نفاذ التسجيل في الضريبة، وفي حال تبين غير ذلك ستقوم هيئة الزكاة والضريبة والجمارك بتنفيذ الغرامات المستحقة

Note: As a VAT registered taxpayer, you are not allowed to collect VAT from your customers prior to the effective date of the tax registration. If otherwise approved, The ZAKAT, Tax and Customs Authority will impose the applicable penalties

ضريبة القيمة المضافة
VAT

zatca.gov.sa 19993 @zatca_sa



هذه الوثيقة مستخرجة من النظام الآلي ولا تحتاج إلى توقيع
و لا يعتد بهذه الشهادة إلا بعد التحقق من موقع الهيئة
www.zatca.gov.sa

100241101280909

TIN 3112278034 الرقم المميز
Certificate No. 100241101280909 رقم الشهادة
Certificate date 28/03/2022 تاريخ الشهادة

هيئة الزكاة والضريبة والجمارك
Zakat, Tax and Customs Authority
المملكة العربية السعودية
Kingdom of Saudi Arabia

قائمة فروع المكلف List of Taxpayer Branches

المدينة City	اسم الفرع Branch Name	رقم سجل تجاري / رخصة / عقد CR / License / Contract Number
الرياض Riyadh	شركة التخطيط الحديث للمقاولات شركة شخص واحد	1010681411
الرياض Riyadh	شركة التخطيط الحديث للصناعات المعدنية	1010925784

ضريبة القيمة المضافة
VAT

zatca.gov.sa 19993 @zatca_sa



هذه الوثيقة مستخرجة من النظام الآلي ولا تحتاج إلى توقيع
و لا يعتد بهذه الشهادة إلا بعد التحقق من موقع الهيئة
www.zatca.gov.sa

LEGAL DOCUMENTS



٧٠٣٥٦٨٥١٥٠ : الرقم الموحد
١٠١٠٩٢٥٧٨٤ : رقم المنشأة
١٤٤٥/٠٣/١٧ هـ : التاريخ

شهادة تسجيل فرع شركة Branch Of Company Registration Certificate



الاسم التجاري للشركة : شركة جبل القلعة للمقاولات
نوعها : ذات مسئولية محدودة
مركزها الرئيسي : 0000 الرياض 0000
هاتف :
الرمز البريدي :
ص.ب :
رقم سجل المركز الرئيسي : ١٠١٠٢٧٩٧٤٨
تاريخه : ١٤٣١/٠١/٢٦ هـ
مصدره : الرياض
الاسم التجاري : شركة التخطيط الحديث للصناعات المعدنية
العنوان : ٢٦٠٦، القتم، ٦٩٢٦
هاتف :
الرمز البريدي : ١٣٢٤٦
ص.ب :
النشاط : للاطلاع على بيانات الأنشطة الرجاء مسح الرمز التجاري
ملكية الشركة : مختلطة
اسم المدير (رباعيا) : زيد ربحي ابراهيم ابو نصير
الجنسية : أردني
تاريخ الميلاد : ١٣٩٧ هـ
مكان الميلاد :
رقم السجل المدني : ٢٣٢٩٥٨٨٤٠٠
تاريخه :
مصدره :
سلطات المدير : حسب ما نص عليه عقد الشركة
تاريخه :
مصدره :
يشهد مكتب السجل التجاري بمدينة : الرياض
بأنه تم تسجيل فرع الشركة المذكورة أعلاه بمدينة : الرياض
وتنتهي صلاحية الشهادات في : ١٤٤٦/٠٣/١٧ هـ
بموجب الإيصال رقم : ٢٤١١٧٧٠٢
وتاريخ : ١٤٤٥/٠٦/١١ هـ



يحتكم التظن من صحة هذه الشهادة بالتدول على <http://mc.gov.sa> To Verify The Information Of This Certificate Visit
+966 11 294 4444 | الرياض 11162 | Kingdom of Saudi Arabia | المملكة العربية السعودية | www.mc.gov.sa MCgovSA

ISO CERTIFICATES

CERTIFICADO - CERTIFICATE - CERTIFIKAT - 证书 - 증명서 - CERTIFICA



Certificate Awarded to
MODERN PLANNING CONTRACTING COMPANY LTD
 Unit No 9, 8530 Abi Bakr As Siddiq - Al Mursalat Dist, Riyadh 12464 - 3833,
 Kingdom of Saudi Arabia



Original: Caysif Industrial Khayr
 Modern Planning Contracting Co.

European Register for Standardisation Ltd certifies that the management system of the above organisation has been assessed and found to be in compliance with requirements for the standard below:

ISO 9001:2015
Quality Management Systems

Scope of Certification

"Design, Manufacture, Supply & Erection of Steel Structural Works (Heavy, Medium & Light), Aluminium Works, including but not limited to Building Façade, Canopies, Skylights, Walkways, Elevators Structures, Staircases, Bridges, Platforms, Metal Works (Ladders, Handrails, Trench Covers, Gratings), Steel Tanks (Chillers, Storage, Thermal, Pressurized, Diesel), Aluminium Claddings, Windows, Doors, Balustrades & General Civil Construction Works, Covering Residential Commercial, Industrial, Energy, Oil & Gas and Telecom Industries".

Certificate No : 44.23171.90
 Initial Certification Date : 23-02-2023
 Issue Date : 23-02-2023
 Expiry Date : 22-02-2026



Certifications Director

The validity of the certificate is subject to periodic surveillance audits & on a complete review of the management system every three years. ERS accepts responsibility for proven gross negligence.

For information concerning the validity of the certificate, please scan the above QR Code or visit www.erscert.com





Corporate Office:
 71-75, Shelton Street, Covent Garden, London, WC2E 8JZ, United Kingdom.

CERTIFICADO - CERTIFICATE - CERTIFIKAT - 证书 - 증명서 - CERTIFICA



Certificate Awarded to
MODERN PLANNING CONTRACTING COMPANY LTD
 Unit No 9, 8530 Abi Bakr As Siddiq - Al Mursalat Dist, Riyadh 12464 - 3833,
 Kingdom of Saudi Arabia



Original: Caysif Industrial Khayr
 Modern Planning Contracting Co.

European Register for Standardisation Ltd certifies that the management system of the above organisation has been assessed and found to be in compliance with requirements for the standard below:

ISO 45001:2018
Occupational Health & Safety Management Systems

Scope of Certification

"Design, Manufacture, Supply & Erection of Steel Structural Works (Heavy, Medium & Light), Aluminium Works, including but not limited to Building Façade, Canopies, Skylights, Walkways, Elevators Structures, Staircases, Bridges, Platforms, Metal Works (Ladders, Handrails, Trench Covers, Gratings), Steel Tanks (Chillers, Storage, Thermal, Pressurized, Diesel), Aluminium Claddings, Windows, Doors, Balustrades & General Civil Construction Works, Covering Residential Commercial, Industrial, Energy, Oil & Gas and Telecom Industries".

Certificate No : 44.23171.45
 Initial Certification Date : 23-02-2023
 Issue Date : 23-02-2023
 Expiry Date : 22-02-2026



Certifications Director

The validity of the certificate is subject to periodic surveillance audits & on a complete review of the management system every three years. ERS accepts responsibility for proven gross negligence.

For information concerning the validity of the certificate, please scan the above QR Code or visit www.erscert.com





Corporate Office:
 71-75, Shelton Street, Covent Garden, London, WC2E 8JZ, United Kingdom.

CERTIFICADO - CERTIFICATE - CERTIFIKAT - 证书 - 증명서 - CERTIFICA



Certificate Awarded to
MODERN PLANNING CONTRACTING COMPANY LTD
 Unit No 9, 8530 Abi Bakr As Siddiq - Al Mursalat Dist, Riyadh 12464 - 3833,
 Kingdom of Saudi Arabia



Original: Caysif Industrial Khayr
 Modern Planning Contracting Co.

European Register for Standardisation Ltd certifies that the management system of the above organisation has been assessed and found to be in compliance with requirements for the standard below:

ISO 14001:2015
Environmental Management Systems

Scope of Certification

"Design, Manufacture, Supply & Erection of Steel Structural Works (Heavy, Medium & Light), Aluminium Works, including but not limited to Building Façade, Canopies, Skylights, Walkways, Elevators Structures, Staircases, Bridges, Platforms, Metal Works (Ladders, Handrails, Trench Covers, Gratings), Steel Tanks (Chillers, Storage, Thermal, Pressurized, Diesel), Aluminium Claddings, Windows, Doors, Balustrades & General Civil Construction Works, Covering Residential Commercial, Industrial, Energy, Oil & Gas and Telecom Industries".

Certificate No : 44.23171.14
 Initial Certification Date : 23-02-2023
 Issue Date : 23-02-2023
 Expiry Date : 22-02-2026



Certifications Director

The validity of the certificate is subject to periodic surveillance audits & on a complete review of the management system every three years. ERS accepts responsibility for proven gross negligence.

For information concerning the validity of the certificate, please scan the above QR Code or visit www.erscert.com





Corporate Office:
 71-75, Shelton Street, Covent Garden, London, WC2E 8JZ, United Kingdom.

SERVICES & PROJECTS

Steel structure works

- Design & Engineering works
- Steel structures general fabrications
- Secondary structures
- Hand rails, Guard rails and Fences
- Silos & Tanks (water, oil)
- Warehouses & Hangers
- Misc. fabrications
- Installation works

حديث للمقاولات
Modern Planning

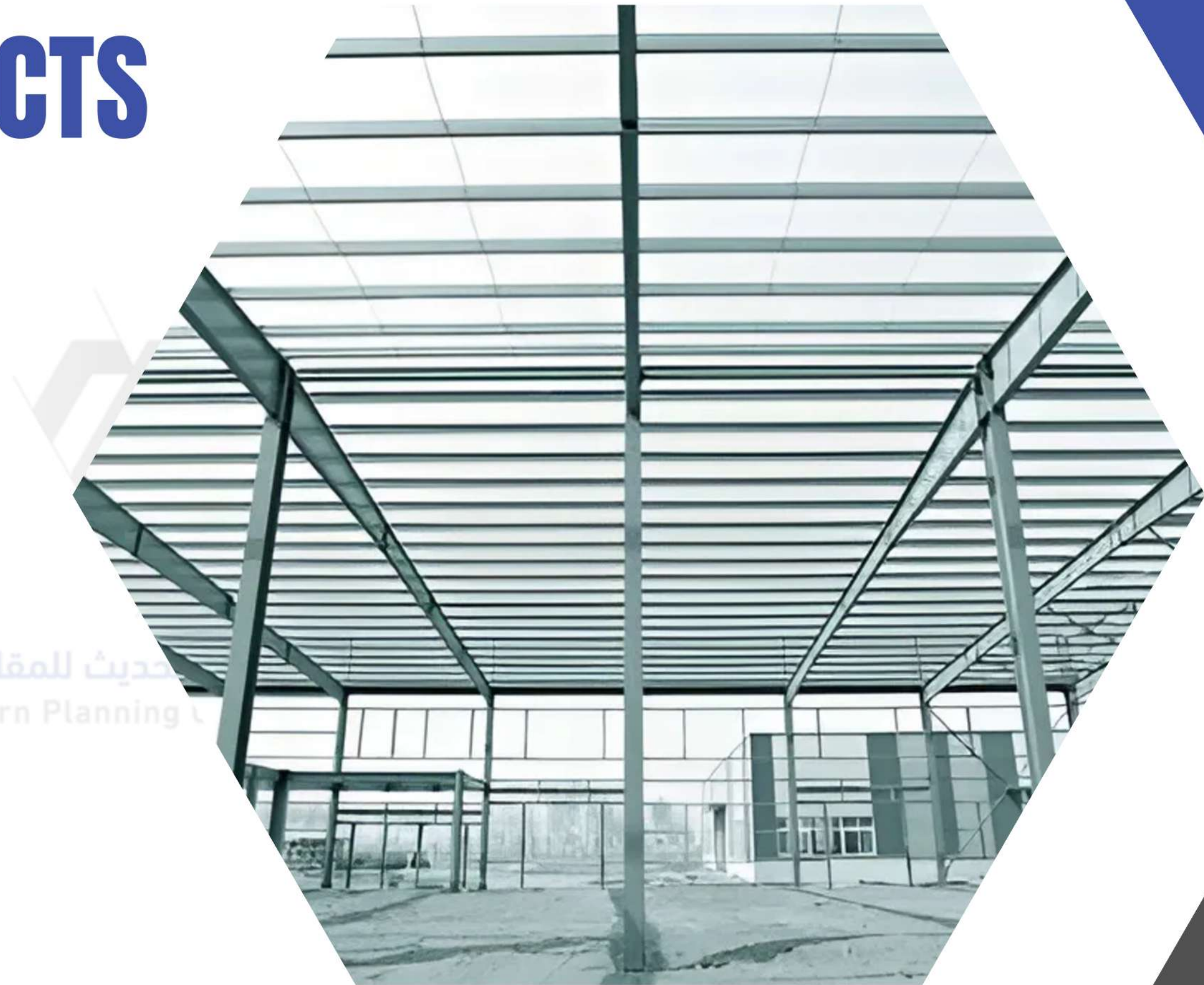

Facilities & Equipment



Facilities & Equipment



Welding Machines



Bending Machine



Airless Spray Machine



Plasma Machine



Cutting Machine



Cranes



Punching Machine



Laser Machine



Sawing Machine



Iron Worker Machine

Project: OXAGON, NEOM

- 250m³ Cement Silo
- Client: El Seif Redco JV.



Project: OXAGON, NEOM



Project: OXAGON, NEOM

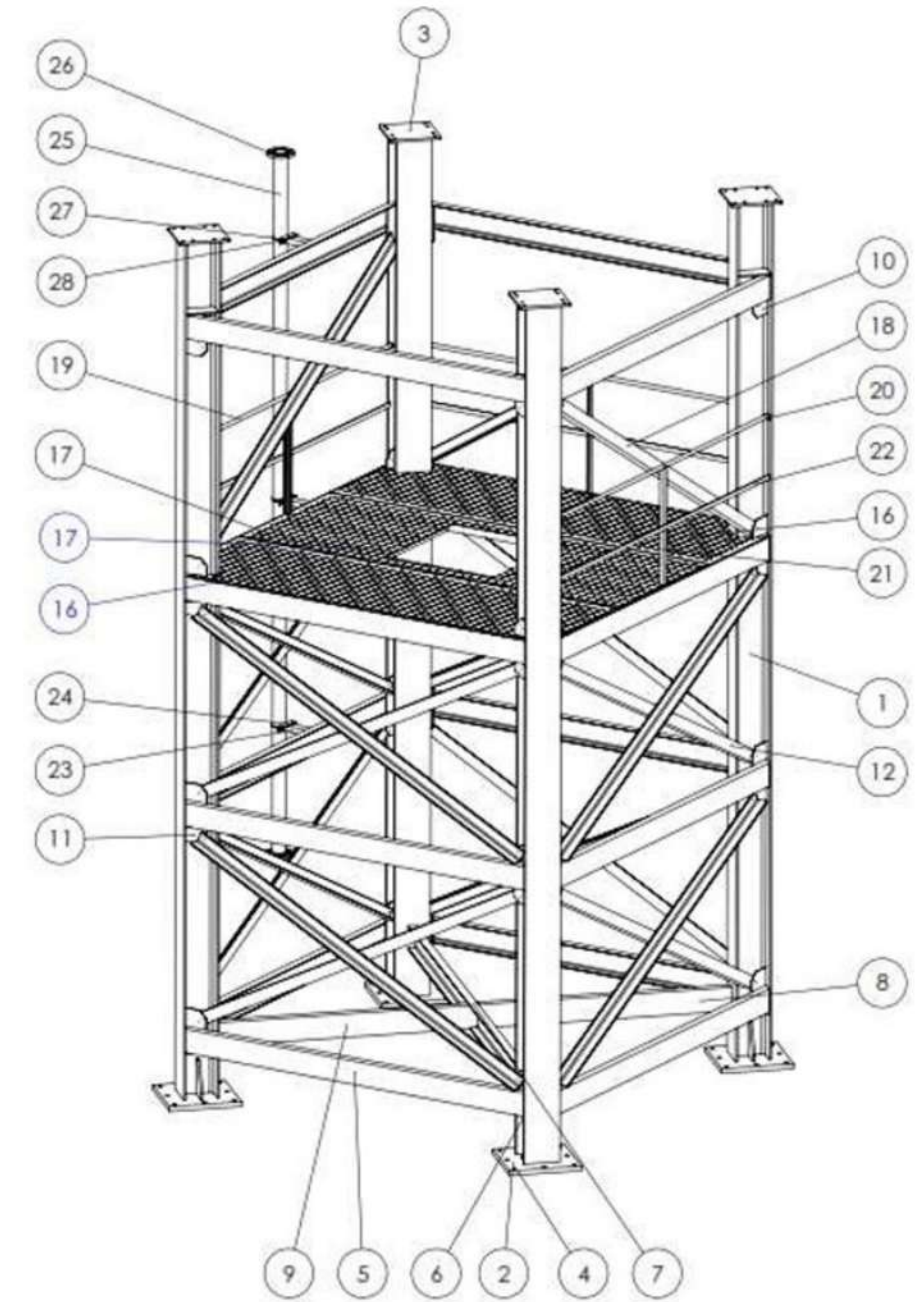
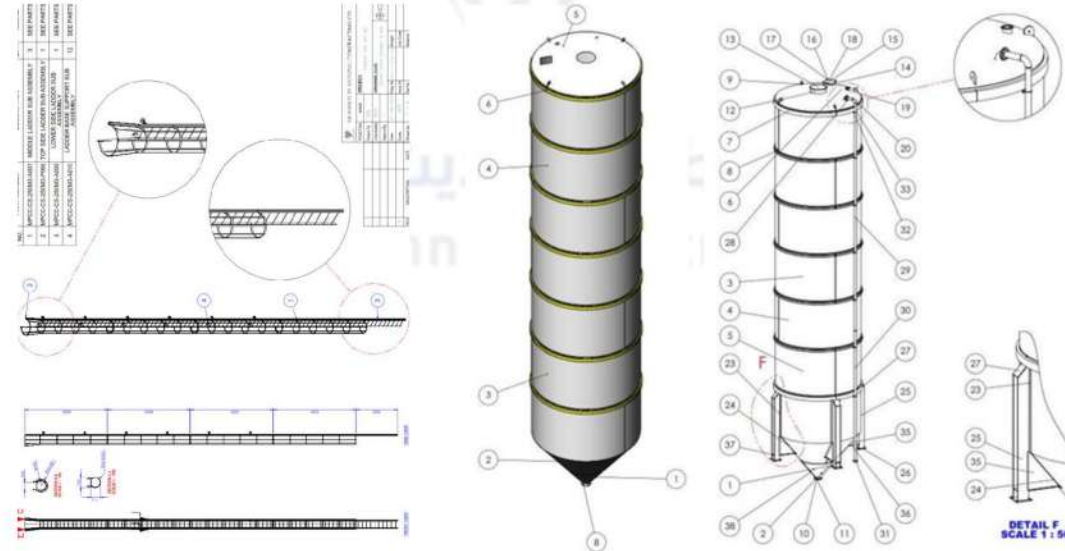

Project: King Abdullah Financial District KAFD – Tower 2.14

- Tower 2.14 Skywalk gap closing
- Client: Al Bawani Construction Co.
- Scope:

Engineering design & structural calculation & of steel structure main frame for the tower gap. Material supply, fabrication, paint, delivery & installation of the main steel frame and secondary structure, cement boards covering.

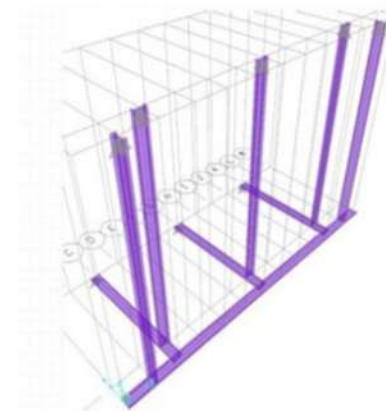
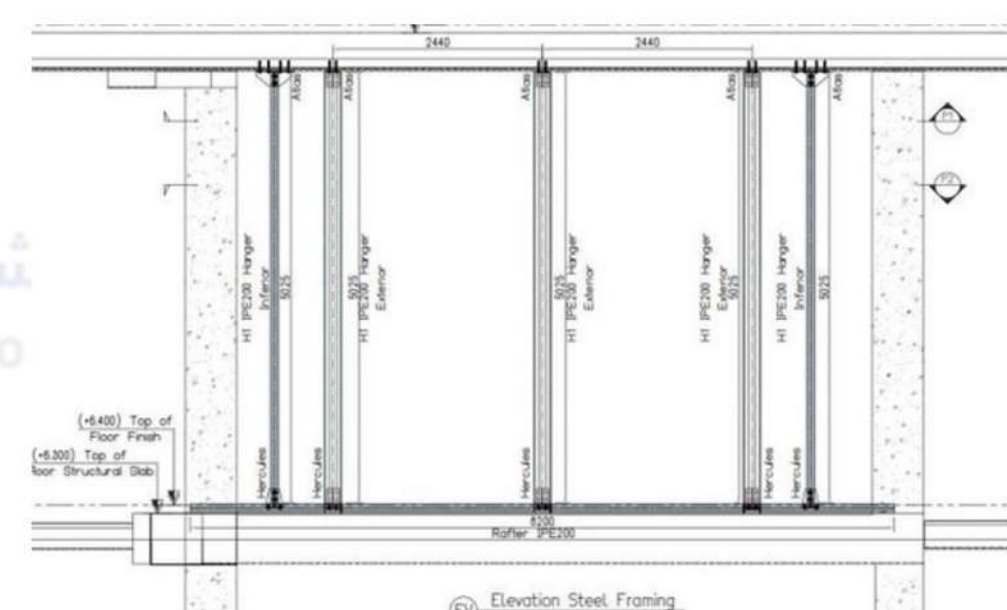
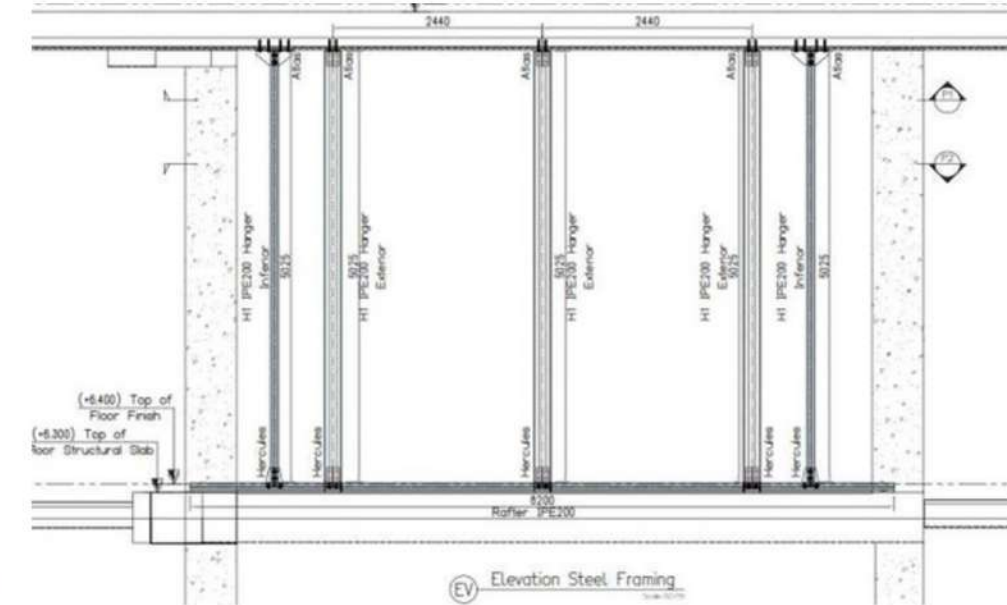
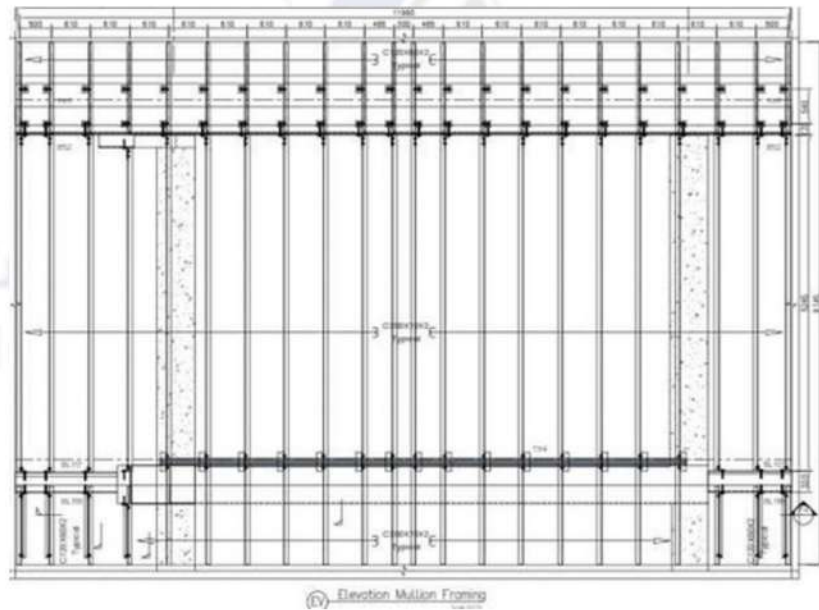

Project: King Abdullah Financial District KAFD - Tower 2.14



Project: King Abdullah Financial District KAFD - Tower 2.14

Programme: King Abdullah Financial District (KAFD)
Observation & Comments Sheet (OCS)

PROJECT / PARCEL	KAFD - P2.14	PROGRAMME No.	KAFD00214
OCS NUMBER	KAFD-A2-214-DAH-DCM-OCS-13327	DATE	15-Mar-22
ORIGINATOR	AL BAWANI CO. LTD.	TRANSMITTAL No. / DATE	P214-ABC-WTRAN-001272
DOCUMENT No.	KAFD-A2-214-ABC-STL-PQD-00002	DISCIPLINE	STL
DOCUMENT TITLE	PRE-QUALIFICATION DOCUMENTS OF MODERN PLANNING FACADE OPENING STEEL STRUCTURAL	DOCUMENT TYPE	PQD

Comments / Replies Legends & Status		Comment Code Legend (for individual comments):		Reply Code Legend:		Open / Closed	
		1 = Action Required; 2 = Note / Advisory / Recommendation		1 = Incorporated; 2 = Not incorporated for reason stated in reply			
No.	Initial	Page / Section / Sheet	Comment Code	Reviewer Comment	Reply Code	Originator Reply	Reply Status by Reviewer
1	MM	GEN	1	PRE-QUALIFICATION DOCUMENTS OF MODERN PLANNING FACADE OPENING STEEL STRUCTURAL is not acceptable.		Noted	Closed
2	MM	GEN	1	Contractor to submit: All the legal certificates and documents. Details of the competent engineers / persons that will be assigned for the site. Approval of previous projects in local markets KSA implemented by the company Any additional documents that help in the evaluation.		Done	Closed
3	MM	GEN	1	Scope of work to be clarified.		Done	Closed
4	MM	GEN	1	Contractor to respect our comments on KAFD-A2-214-ABC-STL-RF1-00004 (Sky walk closure gap Cement board structural calculations.)			

Review Status Code: **B** (A - Approved, B - Approved with Comment, C - Objection, D - No Objection, E - No Objection with Comments)

Reviewer Name(s) / Initials	Position	COMMENTS / STATUS RECOMMENDED BY SC	COMMENTS / STATUS RECOMMENDED BY PMCM	COMMENTS / STATUS ADVISED BY KAFD-DMC	REPLY APPROVED BY
M.Maassarani	Lead structure	Name: Spiridon Mitri Position: Project Director Signature: Date: 15-Mar-22	Name: Francis Dougan Position: Program Director Signature: Date: 15-Mar-22	Name: Position: Signature: Date:	Name: Position: Signature: Date:

Approval or No Objection status from the Reviewer shall be deemed as permission to proceed and shall not constitute acceptance or approval of design details, calculations, analyses, test methods, or materials developed or selected by the Originator and shall not relieve him from full compliance with contract technical specifications and drawings

Programme: King Abdullah Financial District (KAFD)
Observation & Comments Sheet (OCS)

PROJECT / PARCEL	KAFD - P2.14	PROGRAMME No.	KAFD00214
OCS NUMBER	KAFD-A2-214-DAH-DCM-OCS-13739	DATE	29-Mar-22
ORIGINATOR	AL BAWANI CO. LTD.	TRANSMITTAL No. / DATE	P214-ABC-WTRAN-001332
DOCUMENT No.	KAFD-A2-214-ABC-STL-MAR-00003	DISCIPLINE	STL
DOCUMENT TITLE	Steel Structural of Skywalk Opening (Manufacturer: Sabc Saudi Sulf, Supplier: Modern Planning)	DOCUMENT TYPE	MAR

Comments / Replies Legends & Status		Comment Code Legend (for individual comments):		Reply Code Legend:		Open / Closed	
		1 = Action Required; 2 = Note / Advisory / Recommendation		1 = Incorporated; 2 = Not incorporated for reason stated in reply			
No.	Initial	Page / Section / Sheet	Comment Code	Reviewer Comment	Reply Code	Originator Reply	Reply Status by Reviewer
1	MM	GEN		Final Approval subject to :			
2	MM	GEN	1	All Works should be complied with the all requirements of Approved Struct & Facade & ARCH shop drawings and specifications .			
3	MM	GEN	1	Approved Intumescent paint with 120 minutes fire rating should be applied to steel structure and metal deck to meet the code requirements.			
4	MM	GEN	1	All measures and precautions to avoid any damages for the existing structures.			
5	MM	GEN	1	The Contractor should responsible for the design and safety of the system with respect of materials, erection and maintain the proper joining and dismantling.			
6	MM	GEN	1	The warranty should be submitted by the Applicator in compliance with the Project Specification.			
7	MM	GEN	1	WIR and MIR to be submitted as required			
8	MM	GEN	1	Contractor to respect any instructions shall issue by DAH engineers in relation of Application of this material.			

Review Status Code: **B** (A - Approved, B - Approved with Comment, C - Objection, D - No Objection, E - No Objection with Comments)

Reviewer Name(s) / Initials	Position	COMMENTS / STATUS RECOMMENDED BY SC	COMMENTS / STATUS RECOMMENDED BY PMCM	COMMENTS / STATUS ADVISED BY KAFD-DMC	REPLY APPROVED BY
M.Maassarani	Lead Structure	Name: Spiridon Mitri Position: Project Director Signature: Date: 29-Mar-2022	Name: Francis Dougan Position: Program Director Signature: Date: 29-Mar-2022	Name: Position: Signature: Date:	Name: Position: Signature: Date:

Approval or No Objection status from the Reviewer shall be deemed as permission to proceed and shall not constitute acceptance or approval of design details, calculations, analyses, test methods, or materials developed or selected by the Originator and shall not relieve him from full compliance with contract technical specifications and drawings

dar dar al-handasah
AL BAWANI | dar | PARSONS | KAFD

Work Inspection Request

Request Ref.:	KAFD-A2-214-ABC-STL-RE-00004	Revision:	R00	Submission Date:	28/04/2022
Project:	King Abdullah Financial District - Area 2 Buildings	Inspection Date:	27/04/2022	Time:	13:00
Client:	KAFD DMC	Project/Parcel No.:	Parcel P 2.14		
PMCM/Engineer:	Saudi Arabian Parsons Ltd	Contractor:	Albawani		

Discipline: Civil Architectural Structural Landscape MEP Testing/Commissioning HSE Others ()

Work Details:
Description: Supply & Install Steel frame Structural of Skywalk Opening at north elevation 531
BOQ REF.: #s per highlighted attached
Quantity: 5122kg
Approved Method Statement: KAFD-RY-RIA3-P214-ABC-CIV-MES-0003
Approved Inspection and Test Plan: KAFD-RY-RIA3-P214-ABC-CIV-ITP-0003

Location / Level / Room Name & No. / Grid Line: North elevation - 531 - As per highlighted
Attached Approved Drawings:
Attached Location Sketch:
Attached Check Sheet:
Attached Previous Revision (if any):

Contractor's Representative:
Name: Ahmed Shalaby
Signature:
Date: 28/04/2022

Supervision Consultant's Review:
Checks: Site Test Results (if any): Passed Failed Not Applicable
Status of Inspection: Status A (Approved) Status B (Approved with Comments) Status C (Objection)
Comments: Quantities to be reviewed and confirmed by QS / DAH Engineer.
M.Maassarani
Reviewer Name: ZA
Signature:
Date: 7.5.2022

PMCM's Review:
Endorsement: Yes No
Comments:
Reviewer Name:
Signature:
Date: DOMMY

Project: Diriya Gate project

- Mess hall steel building
- Client: Nesma & Partners Co.
- Scope:

Engineering design & structural calculation & of steel structure building. Shop drawings.

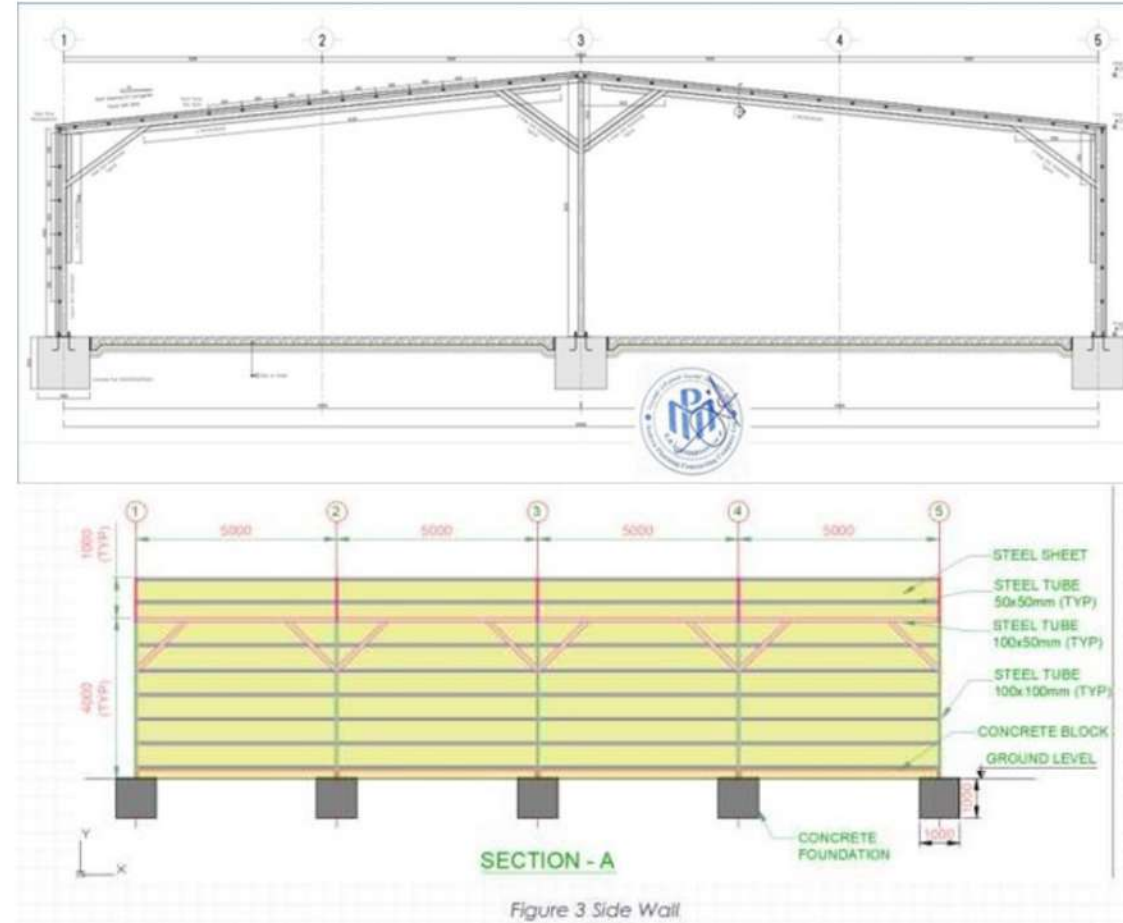
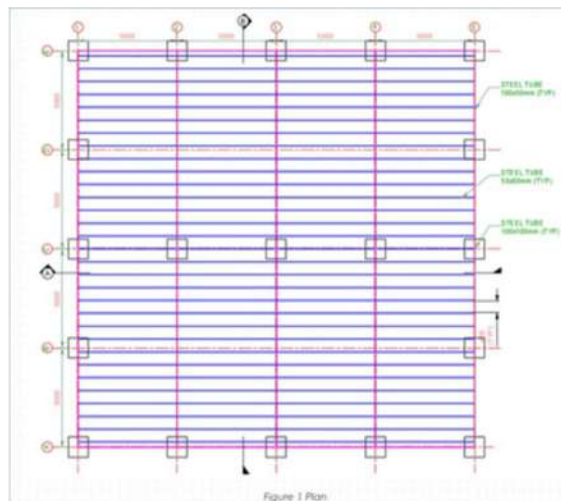

Project: Diriya Gate project

- Boundary fence wall
- Client: Nesma & Partners Co.
- Scope:

Engineering design & shop drawings.

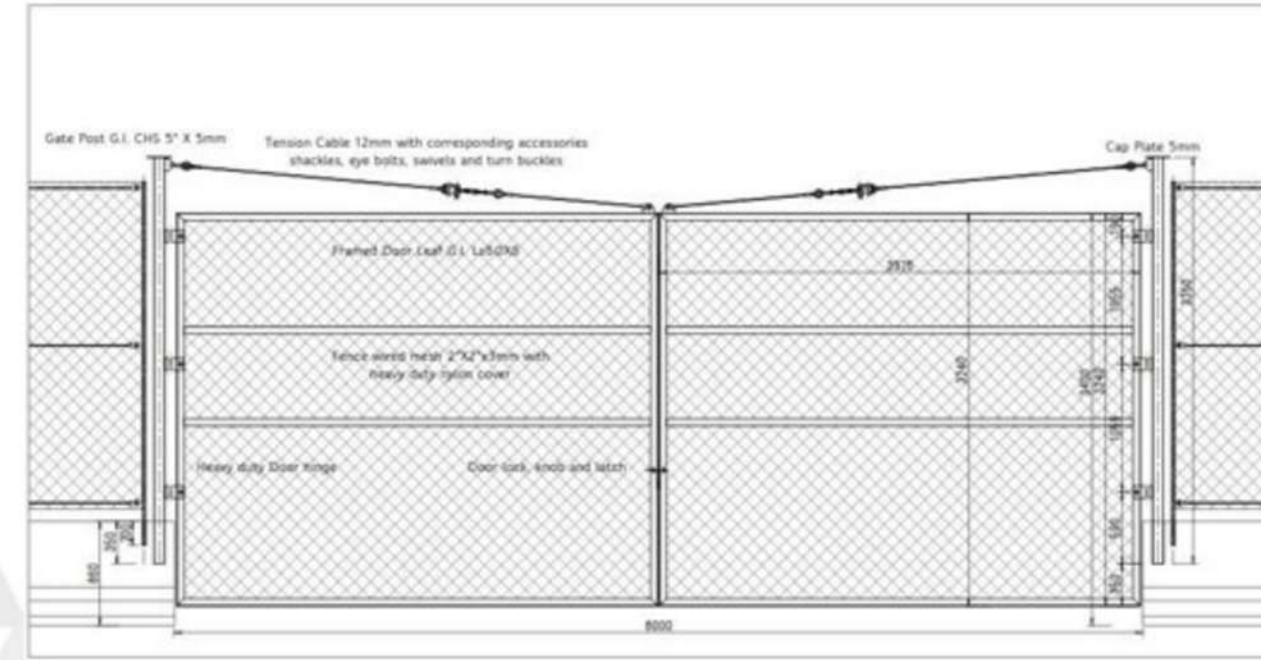
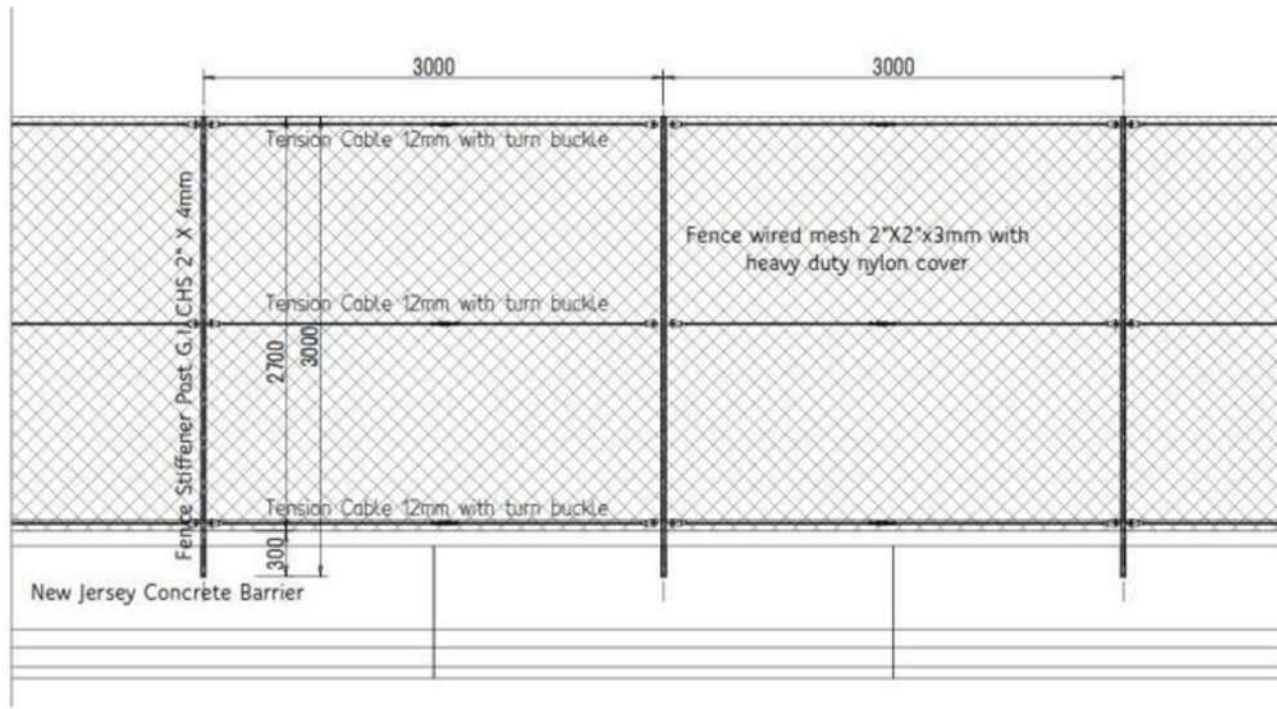

Scale 1:40 A2
Typical Gate Schematic Elevation

CLIENT

 7747 UMRO ADHAMIRY STREET,
 DIPLOMATIC QUARTER,
 UNIT #2, RIYADH 12512,
 KINGDOM OF SAUDI ARABIA
 WWW.DGDA.GOV.SA

PROGRAMME MANAGEMENT CONSULTANT
 *Achieve Ambitions*
 JLL MENA
 17TH FLOOR, SOUTH TOWER,
 ABRAJ ATTAWUNEYA
 KING FAHAD ROAD, SAUDI ARABIA
 PO BOX 13547 RIYADH 11414

DESIGN & ENGINEERING CONSULTANT

 PO BOX 58729 TAWUNIYA TOWERS SOUTH
 TOWER MEZZANINE FLOOR KING FAHAD ROAD
 RIYADH, 11414 KINGDOM OF SAUDI ARABIA
 T: +966 1 200 5100
 WWW.AECOM.COM

MAIN CONTRACTOR
 *نيسما وشركاهم*
 شركة نيسما وشركاهم للتجارة والهندسة
 NESMA & partners contracting co., ltd.
 P.O. BOX 1198 - 88500 - 11511 - Kingdom of Saudi Arabia, Tel: 011-43333333
 هاتف: 011-43333333 - 11511 - الرياض - المملكة العربية السعودية

PROJECT TITLE
DD-2020-280-DIRIYA GATE
314-DSQ Tunnels and Gyrotory (Under WRR)
 PROJECT ADDRESS: AD DIRIYAH, RIYADH, KINGDOM OF SAUDI ARABIA

DRAWING TITLE
Typical Fence and Gates

Sub Contractor
 Modern Planning Company Limited
 Checked By : M.S. Thursday, June 02, 2022

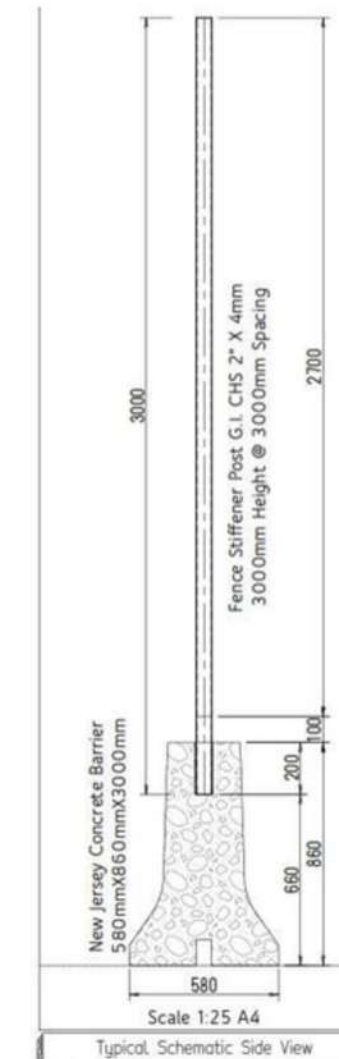

Project: Dallah Pharma Factory project – Jeddah

Renovation of old building , New building expansion

- Client: Al Kshim Co.

- Scope:

- Engineering design & structural calculation

- Material supply

- Primer painting

- Roof & wall sandwich panels supply & installation

- Shop drawings

- Fabrication

- Installation

شركة التخطيط الحديث للمقاولات
Modern Planning Contracting Co.

Project: Dallah Pharma Factory project – Jeddah

- Old building renovation :

Removing old single skin sheets, cleaning, enforcement of steel columns & rafters with additional stiffeners & plates, changing old purlins with new bigger based on the structural calculations, primer paint.



Project: Dallah Pharma Factory project – Jeddah



Cleaning process

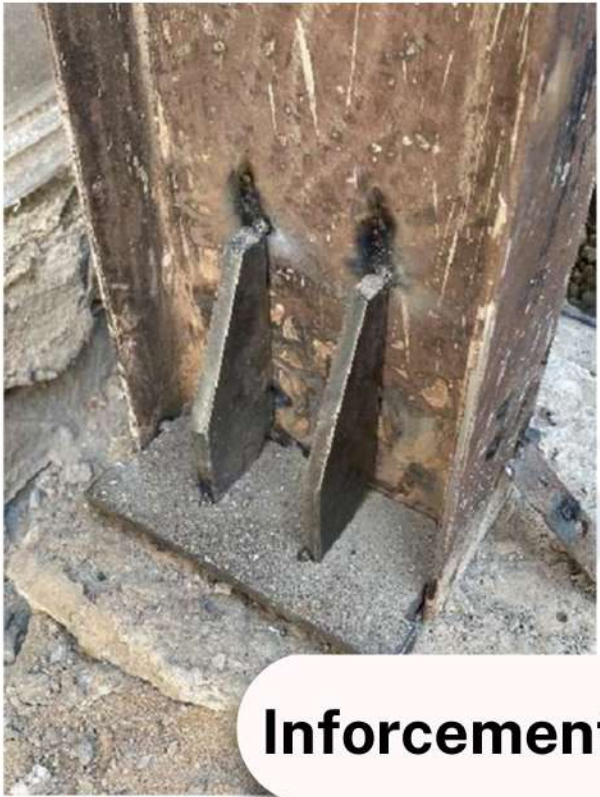

Inforcement process



Project: Dallah Pharma Factory project – Jeddah



Sandwich panels



New building fabrication



Project: King Abdullah Financial District KAFD - tower 406

- Parcel tower 406
- Client: Al Bawani Co
- Scope: Steel structure ceiling platform for electrical rooms

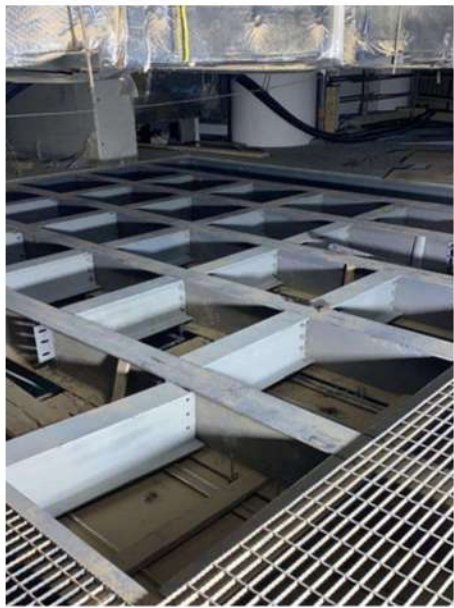
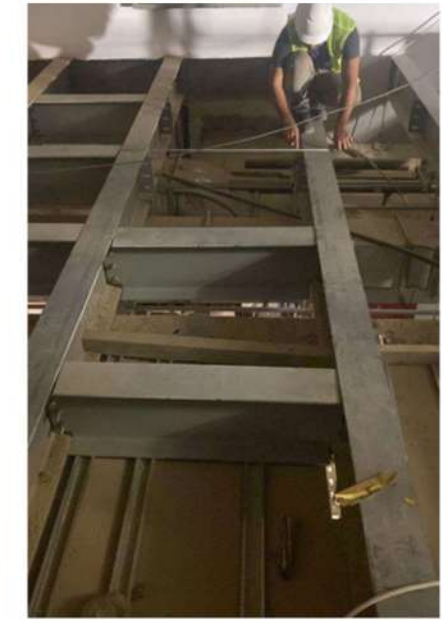
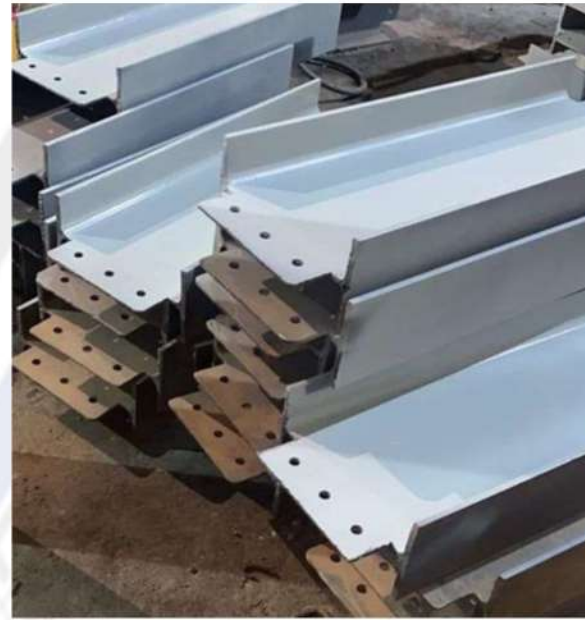

Project: King Abdullah Financial District KAFD – tower 406

- Tower crane supports pipes & brackets
- Client: Al Bawani Co

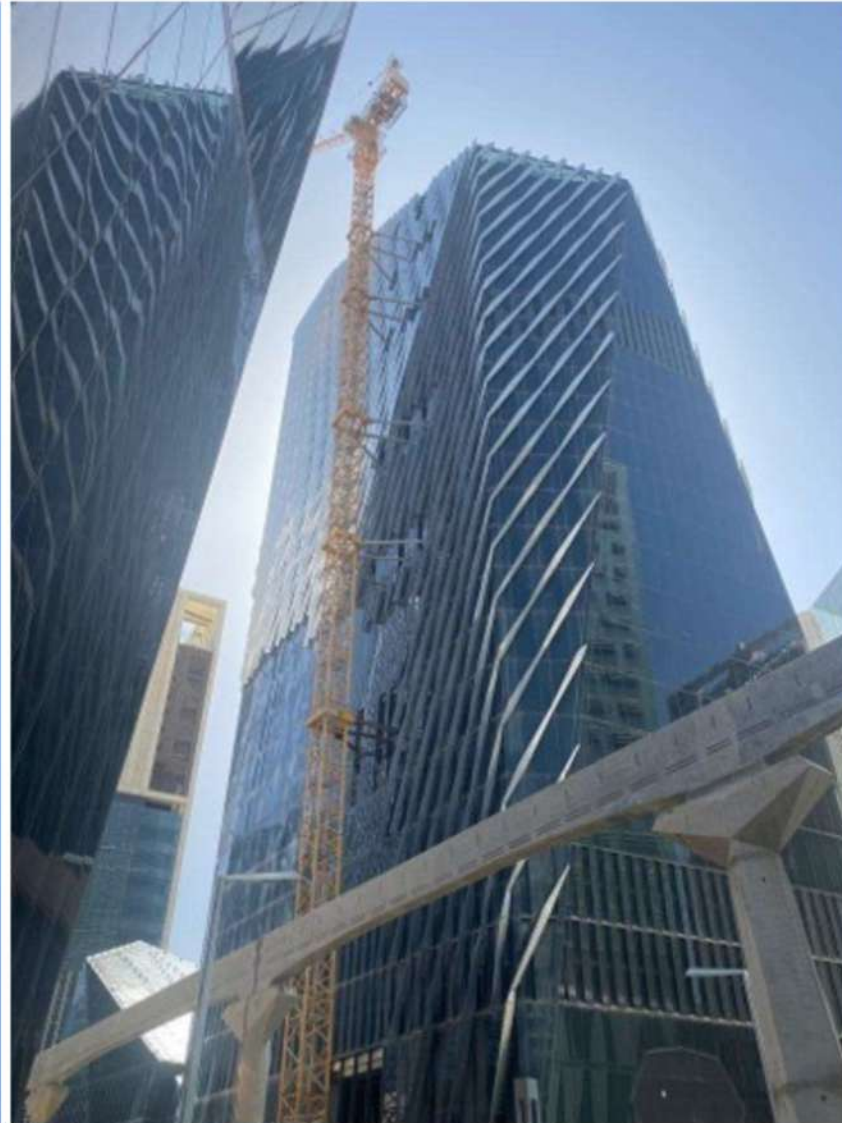

Project: Geo Climate & Museum science buildings KAFD

- Stair cases ceilings sandwich panels and steel frames
- Client: Al Bawani Co



Project: Cordoba Compound

- Stair cases
- Client: Sama Al Sharq Contracting Co.



Project: Vacuum tank 18000 liter

- Client: Itqan Industries Co.



Retal new H.Q Project – Riyadh

- Hoarding
- Client: Retal Urban Development
- Scope:
 - Foundations
 - Plywood
 - Lighting system
 - Steel Frames
 - Adv. Banner



Retal new H.Q Project – Riyadh



Project: Ayala– Khobar

- Branded Fences
- Client: Retal Urban Development



Project: Nesaj Town – Aziziyah – Khobar

- Shinko Fences

- Client: Retal Urban Development

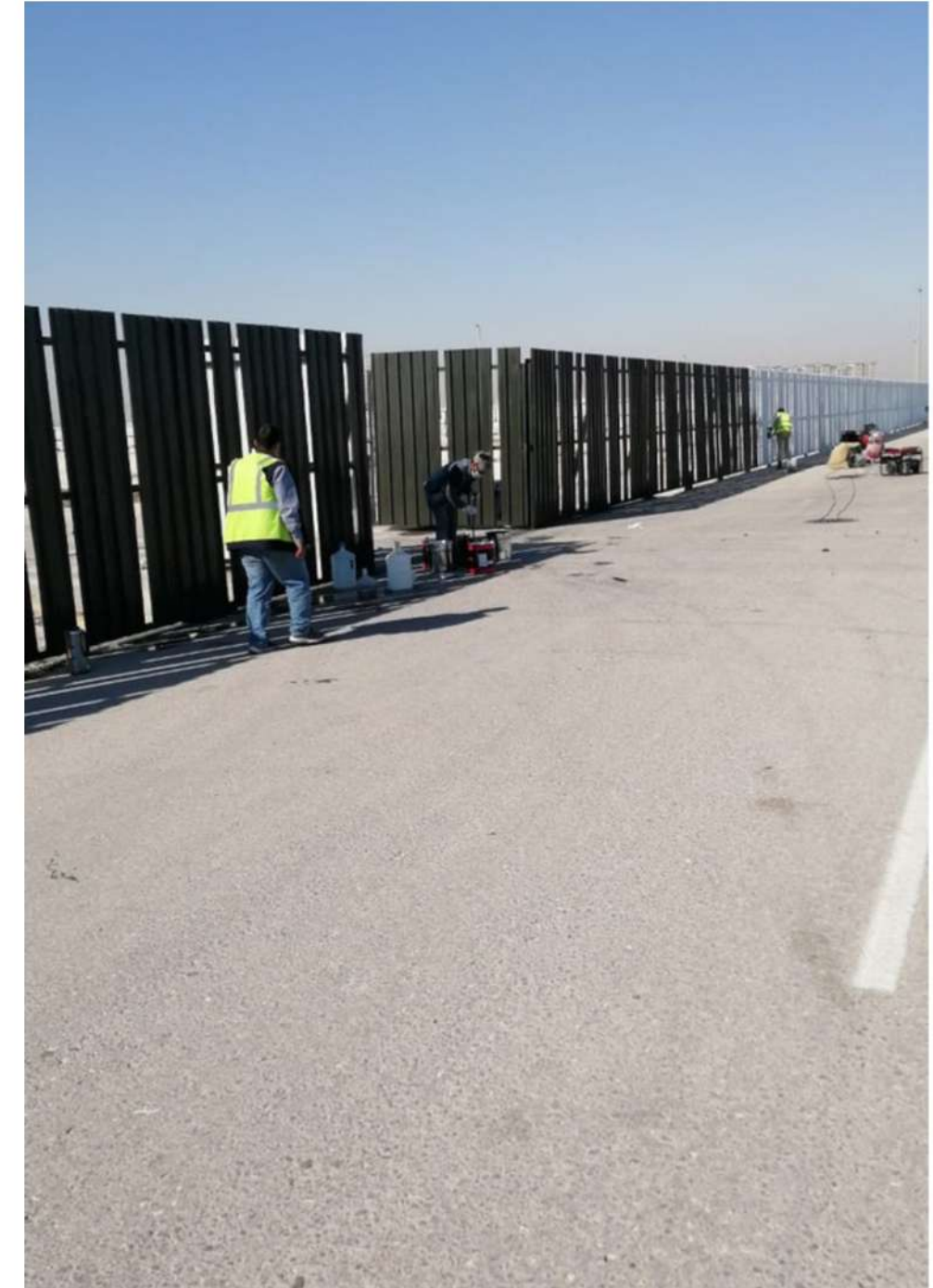

CLADDING WORKS

Project: King Khaled International Airport (KKIA) Aramco

- Tasheelat new petrol station
- Client: Saudi Signs
- Scope:
 - Special Aluminium Sheets cladding works for Orizon Care building and canopies
 - Additional secondary steel structure fabrication & installation for the canopies ceiling cladding.

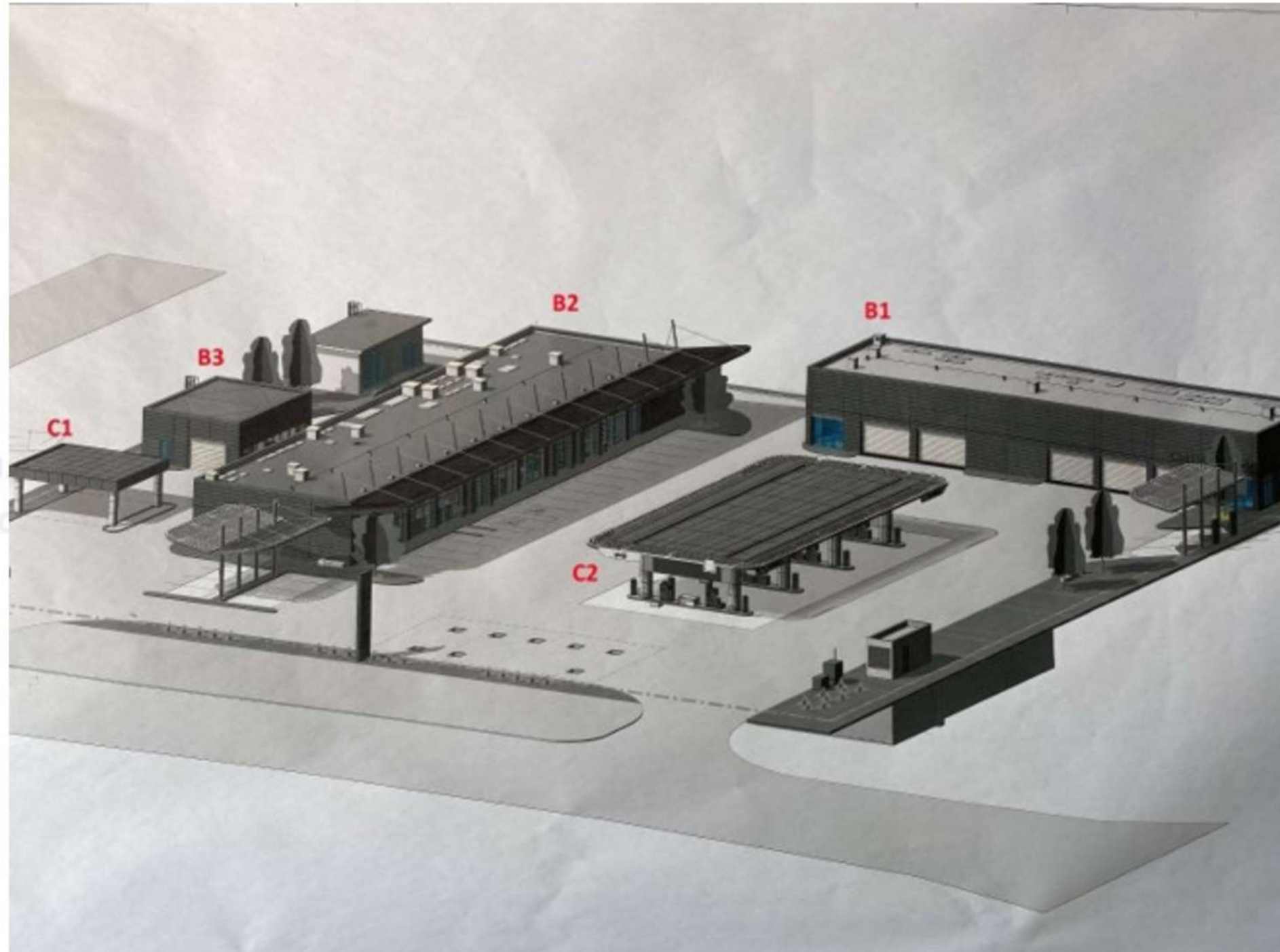

Project: King Khaled International Airport (KKIA) Aramco

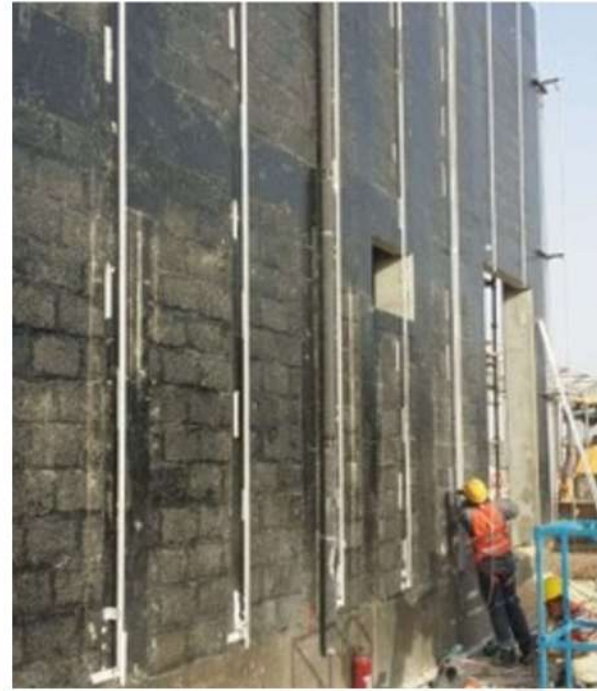

Project: Khobar Aramco Tasheelat new petrol station

- Tasheelat new petrol station
- Client: Saudi Signs
- Scope:

Special Aluminium Sheets cladding works for all building and canopies. Additional secondary steel structure fabrication & installation for the canopies ceiling cladding.

LED lights installation for building and canopies.

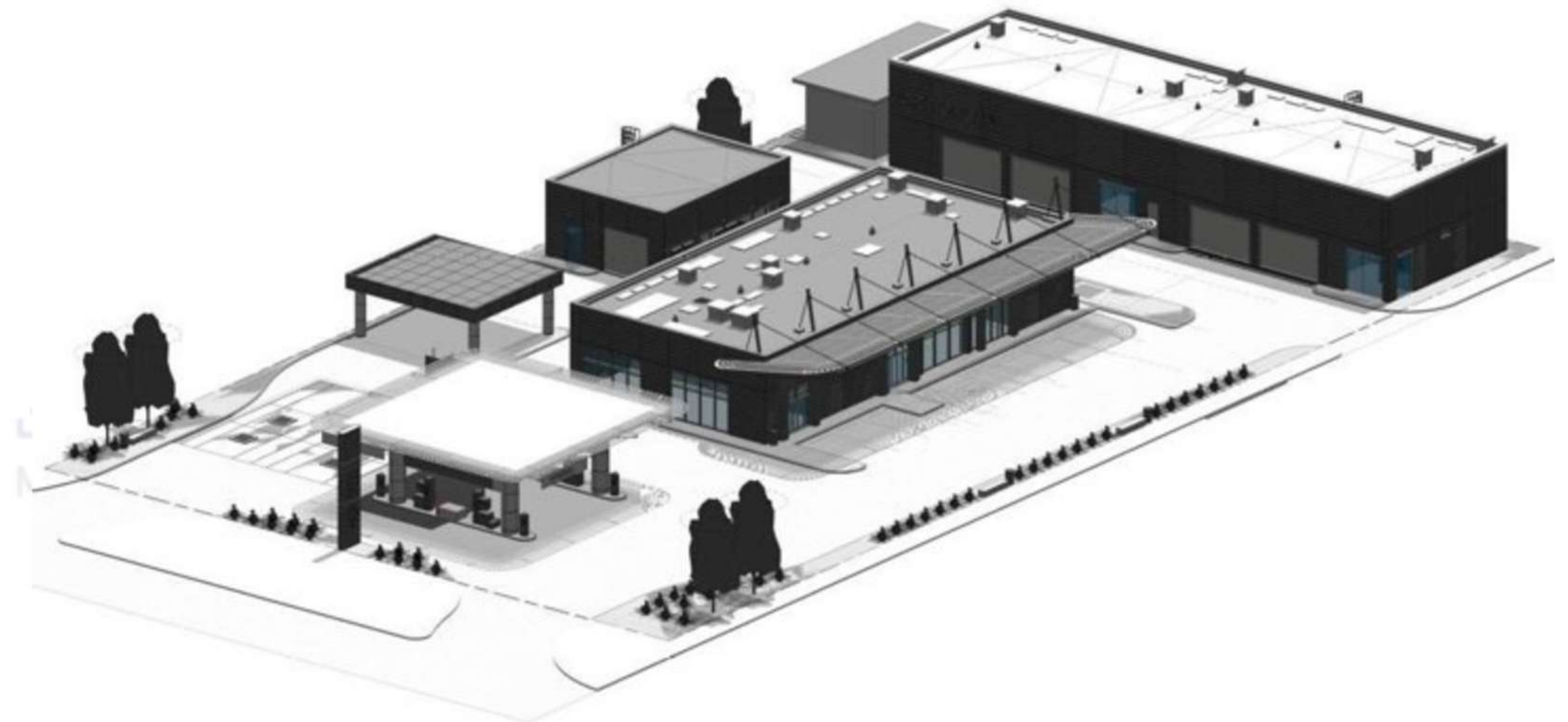

Other Cladding Projects capabilities



Aluminium & Glazing Works

→ Aluminium Canopies

→ Curtain walls / Structural glazing

→ Doors and windows

→ Skylights

→ Pergolas

→ Balustrades & Handrailing

→ ACP Cladding

شركة التخطيط الحديث للمقاولات
Modern Planning Contracting Co.

Aluminium & Glazing Works

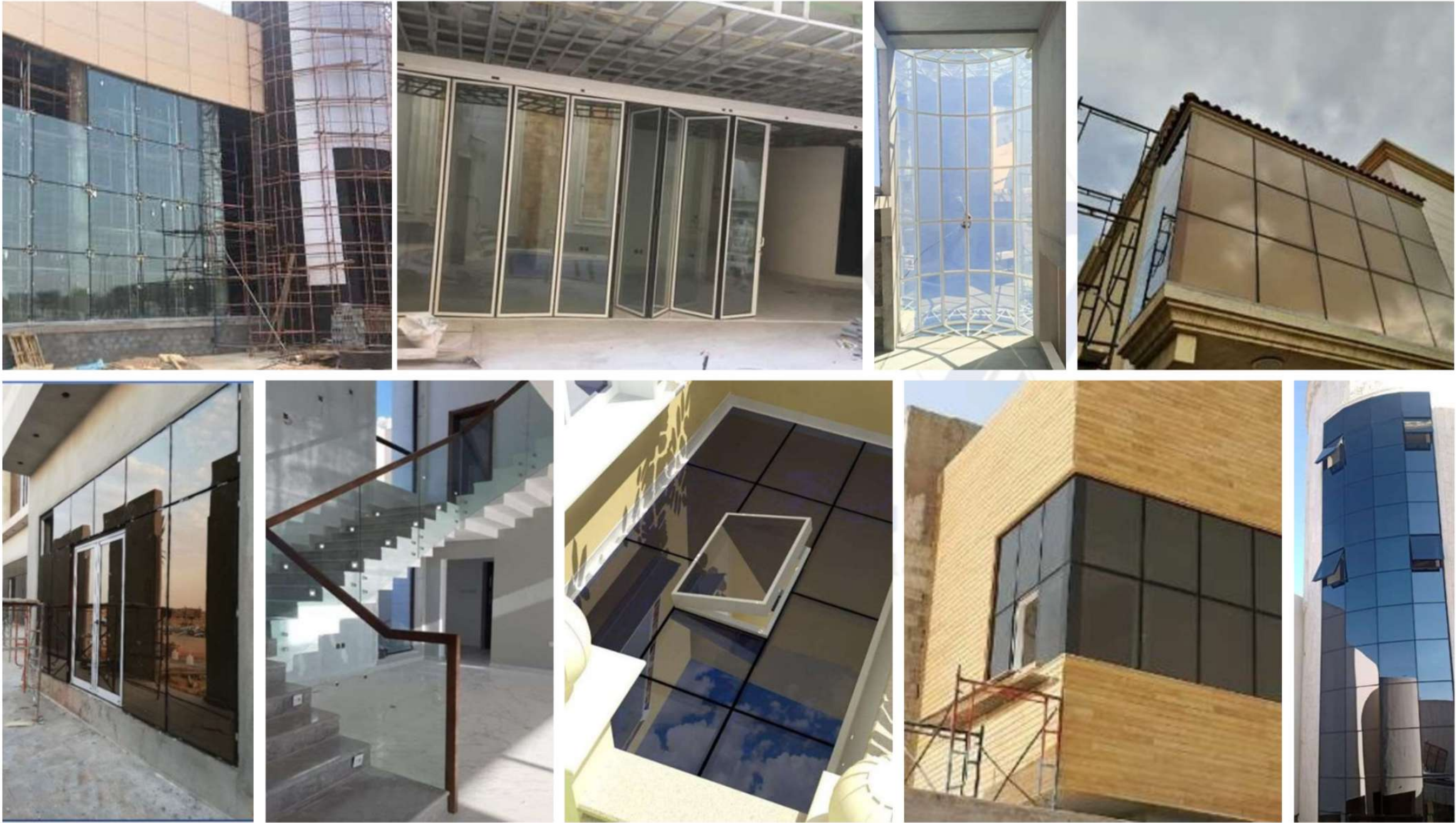

Stone Finish Aluminium panels products

FIT OUTS WORKS & LANDSCAPING

Habbar & Tak offices furnishing project

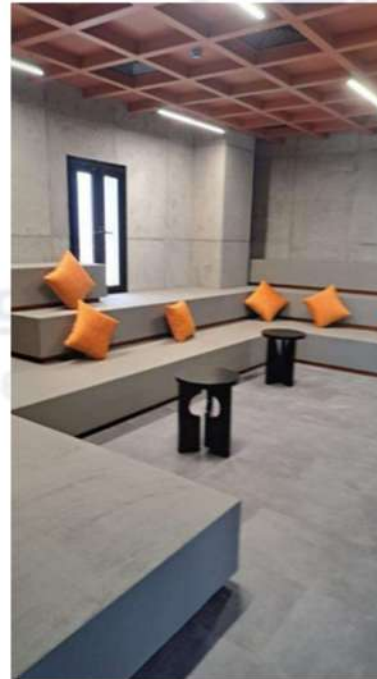
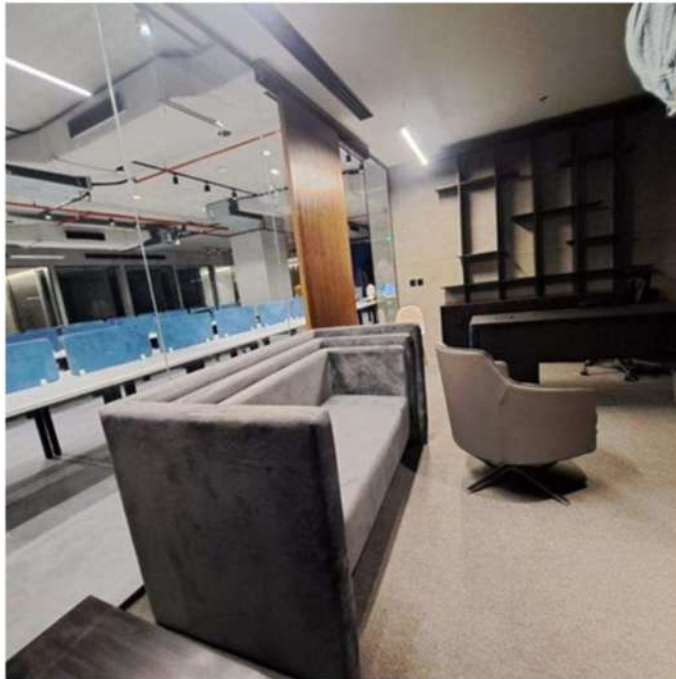
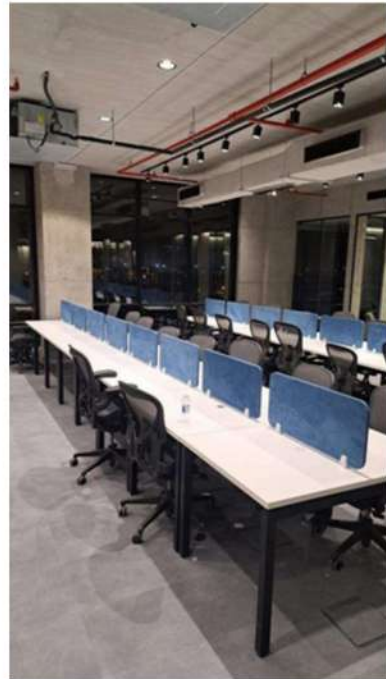
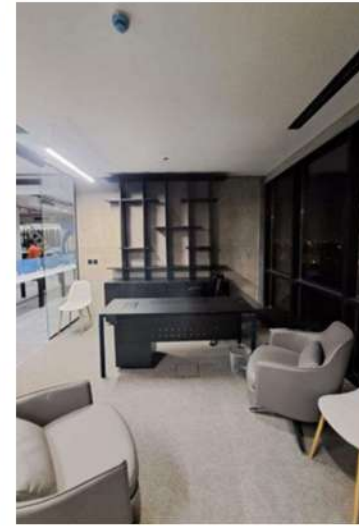
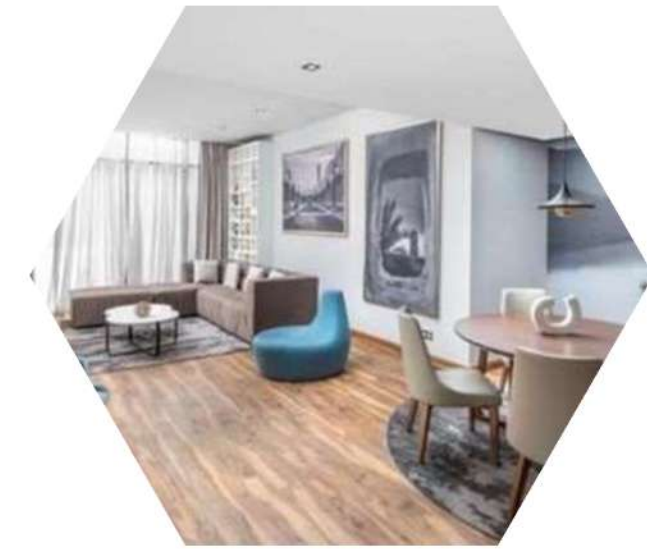

Flamingo Restaurant, Mirrors & Copper

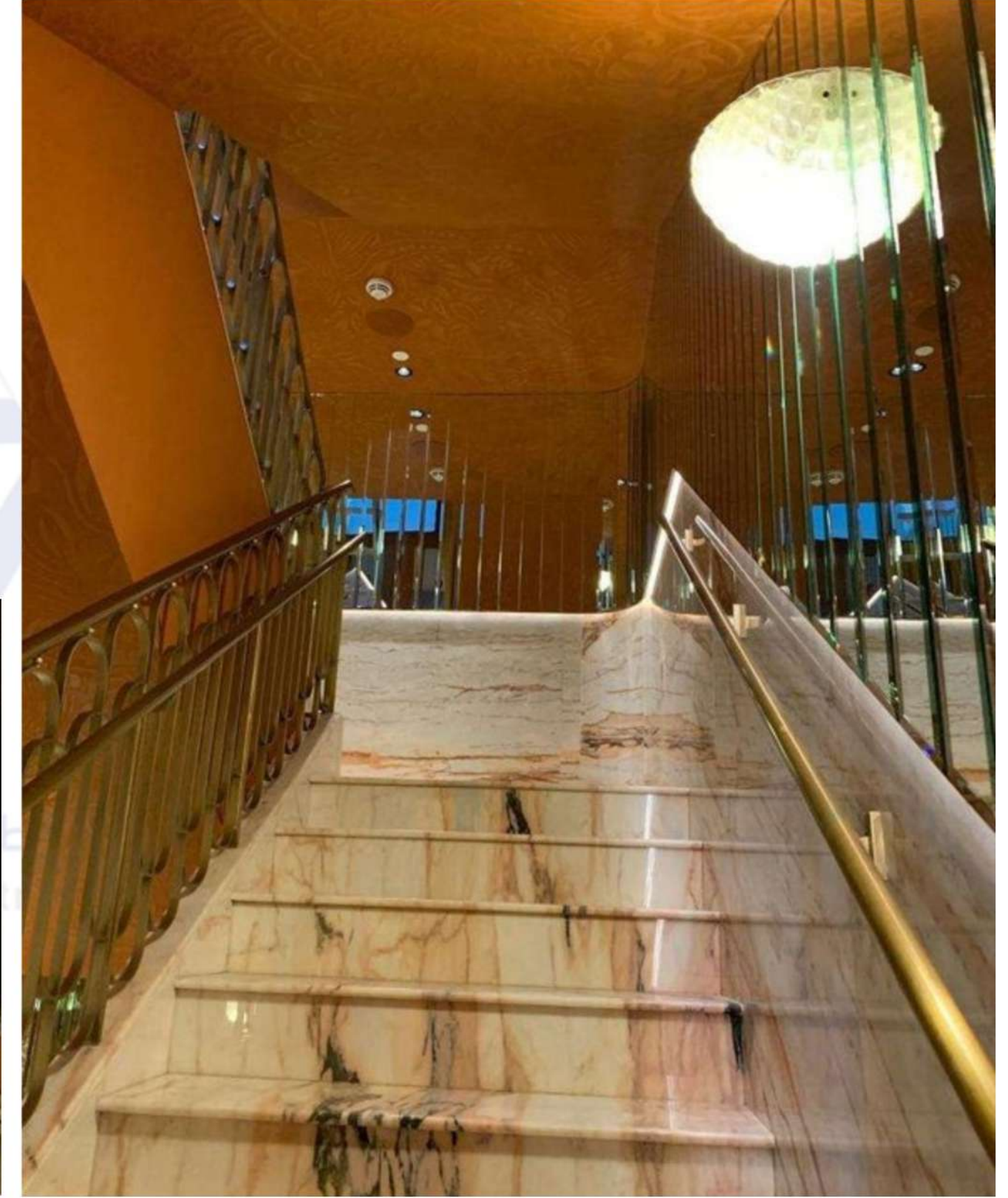
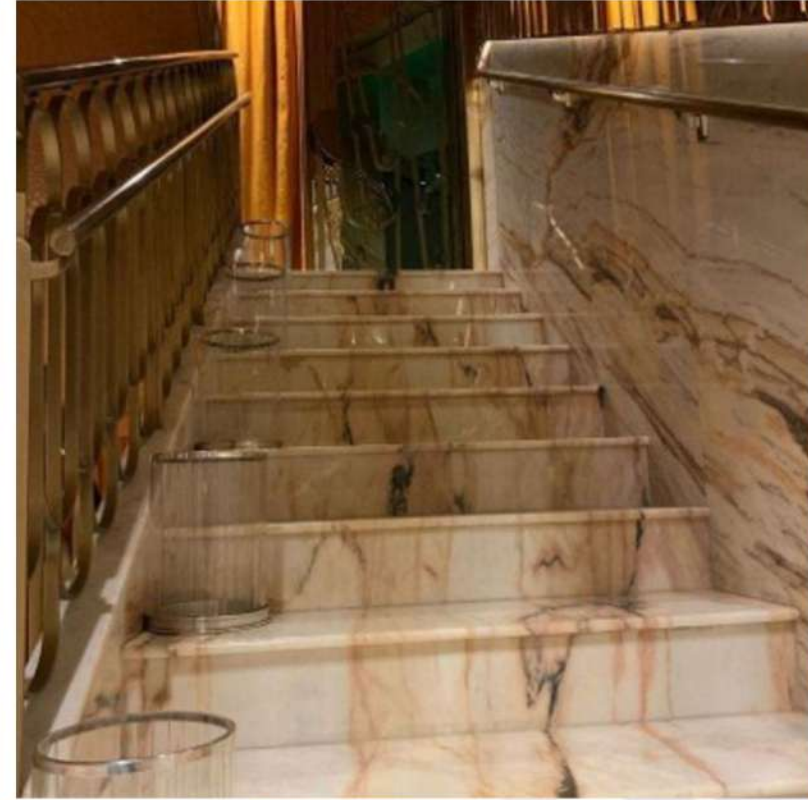

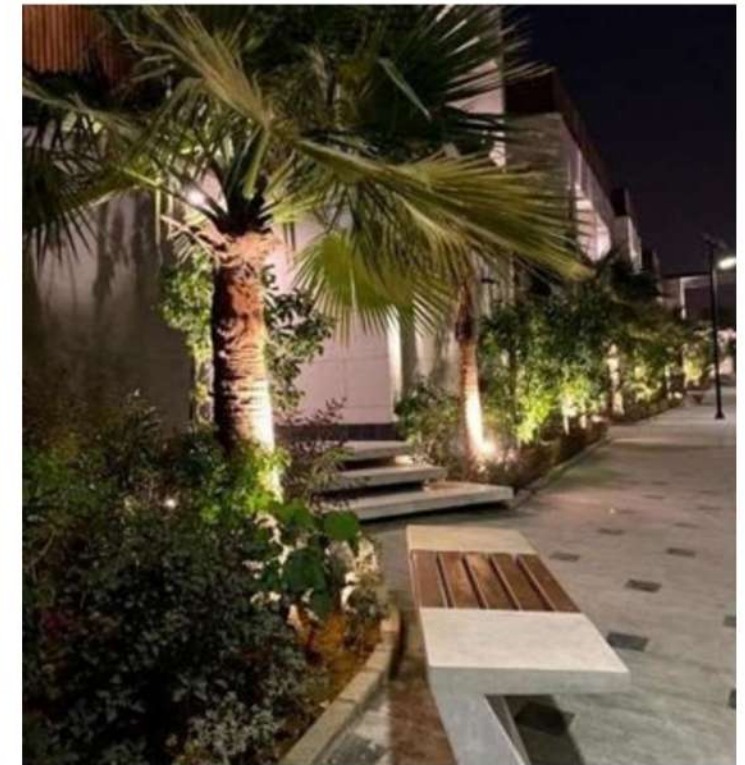

Daylight Systems With Brett Martin

As part of its expansion plans, MPCO became the approved partner of Brett Martin Daylight Systems-UK which is the leading manufacturer of high-quality products of daylight systems since 1958 serving several sectors; Industrial roof lights, Retail & Commercial, Education & Health Care, Hospitality & Leisure, Stadia & Arena, Agricultural, & Residential.

Products range for different needs:

- Sandwich panel skylights
- Single Skin GRP sheets
- Standing Seam skylight
- Barrel-vaulted GRP skylights.
- Barrel-vaulted polycarbonate.
- Façade Glazing.
- Unit skylights.



**Brett
Martin**

WORLD CLASS GLAZING & SKYLIGHTS



مط الحديث للمقاولات
Modern Planning Co

Daylight Systems With Brett Martin

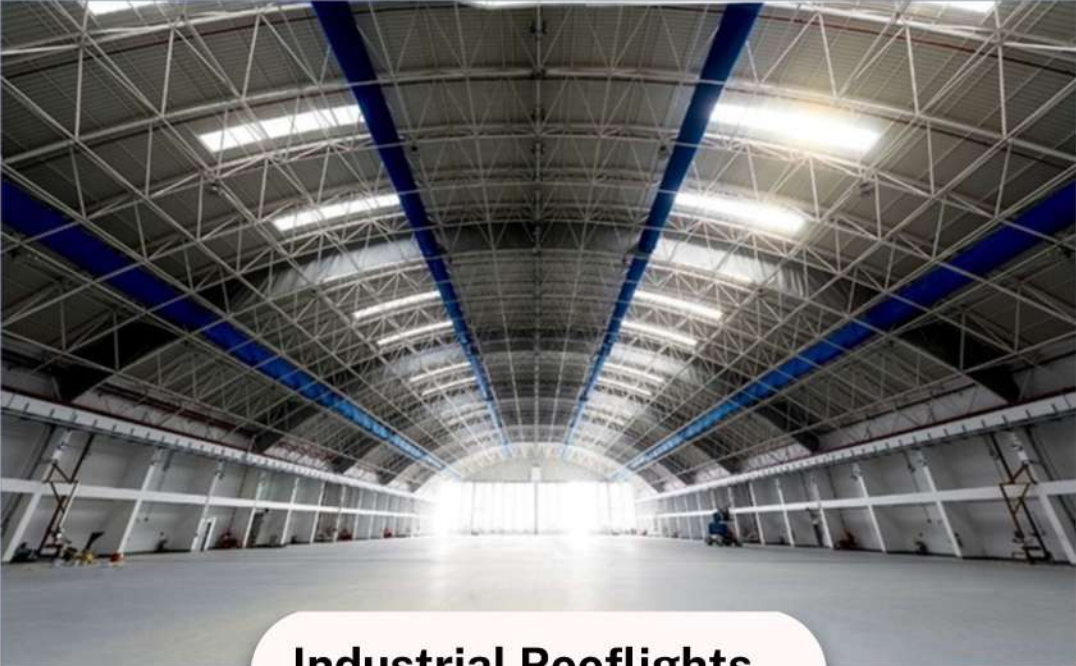

Industrial Rooflights

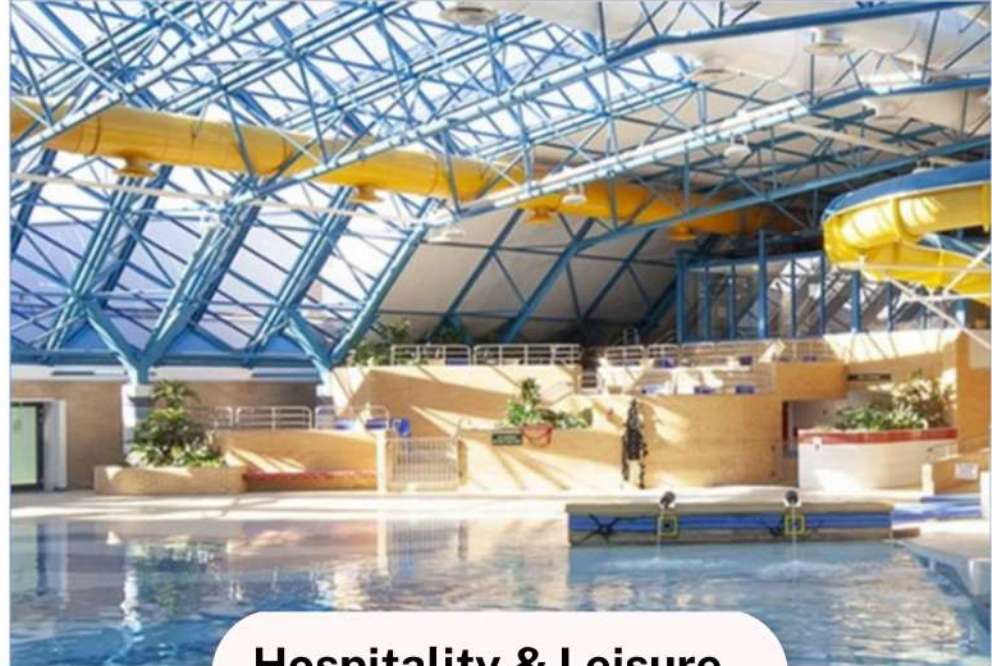

Hospitality & Leisure

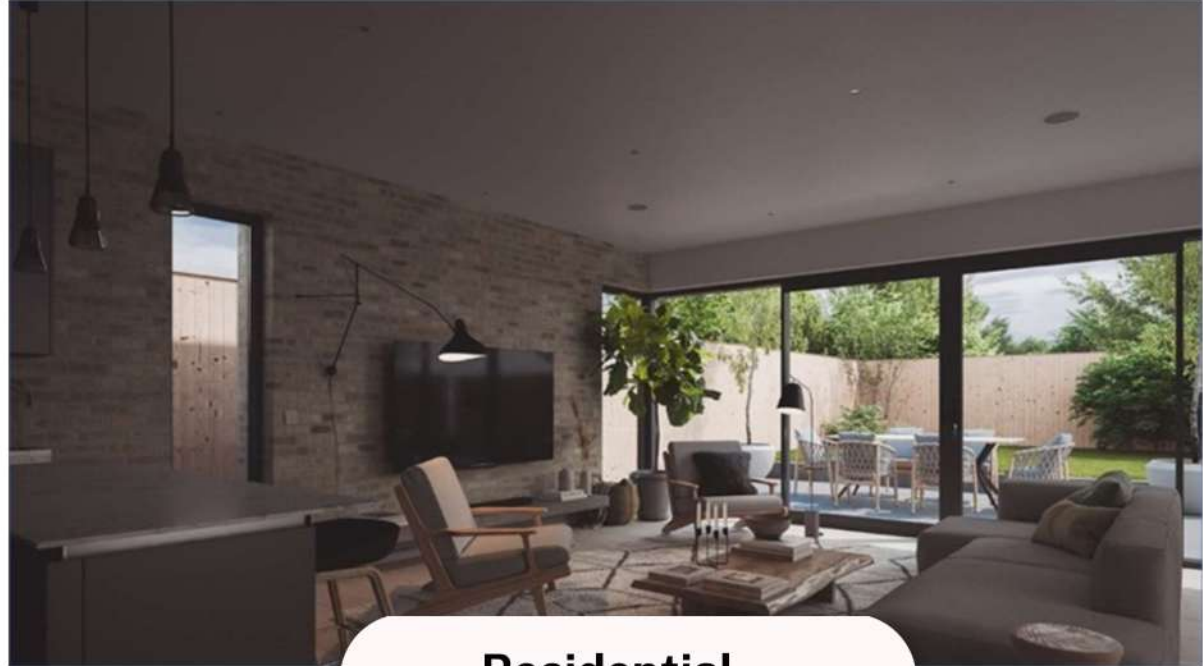

Residential

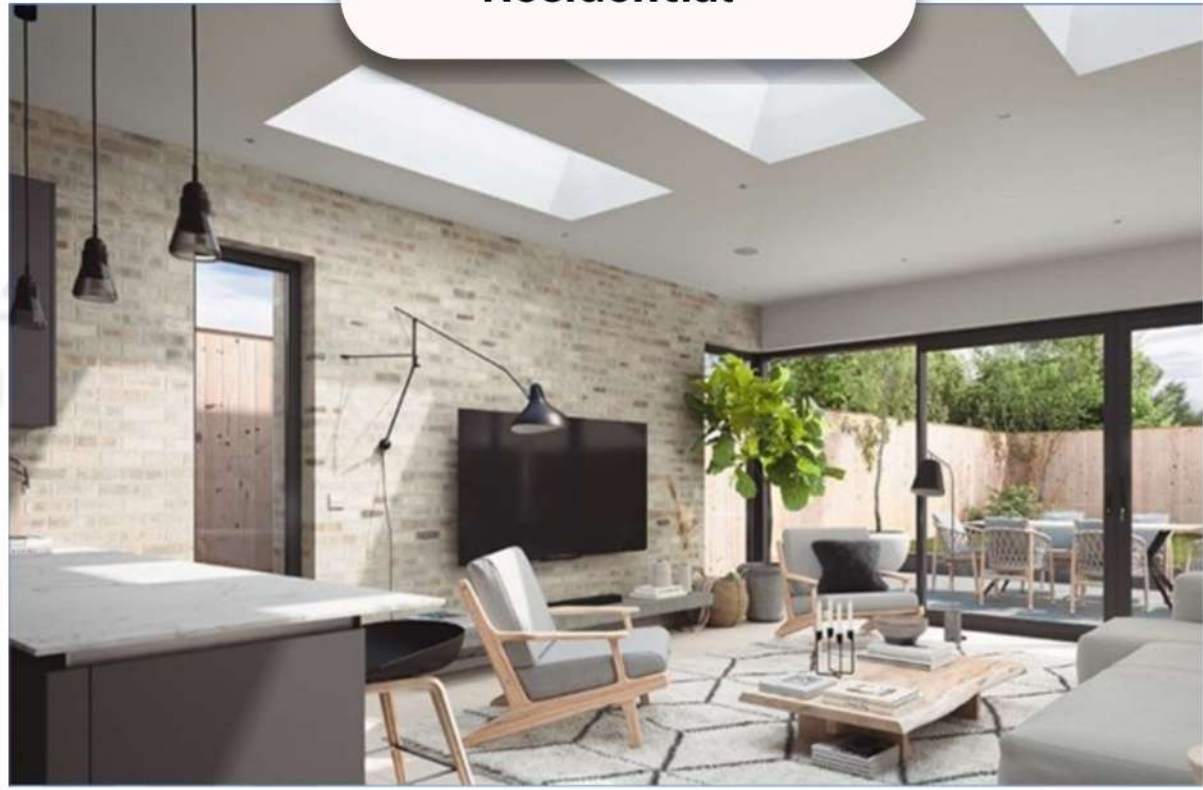

Daylight Systems With Brett Martin



Retail & Commercial



Agriculture

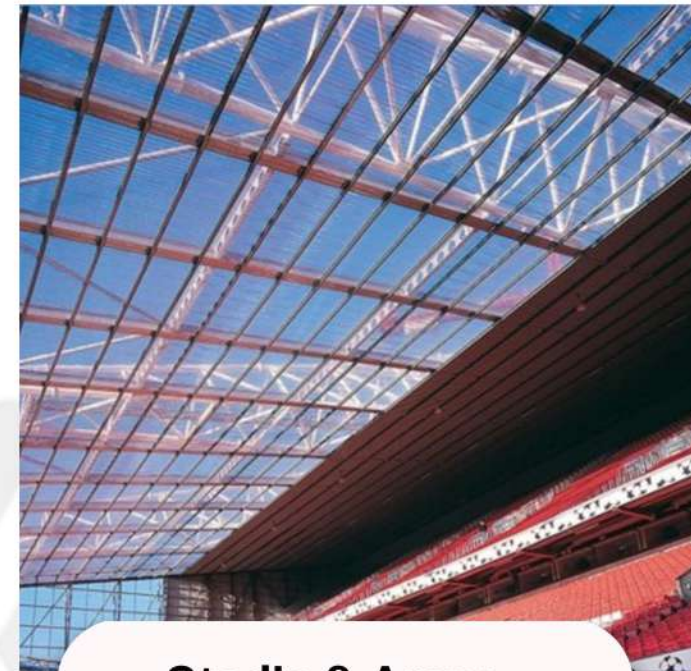

Stadia & Arena

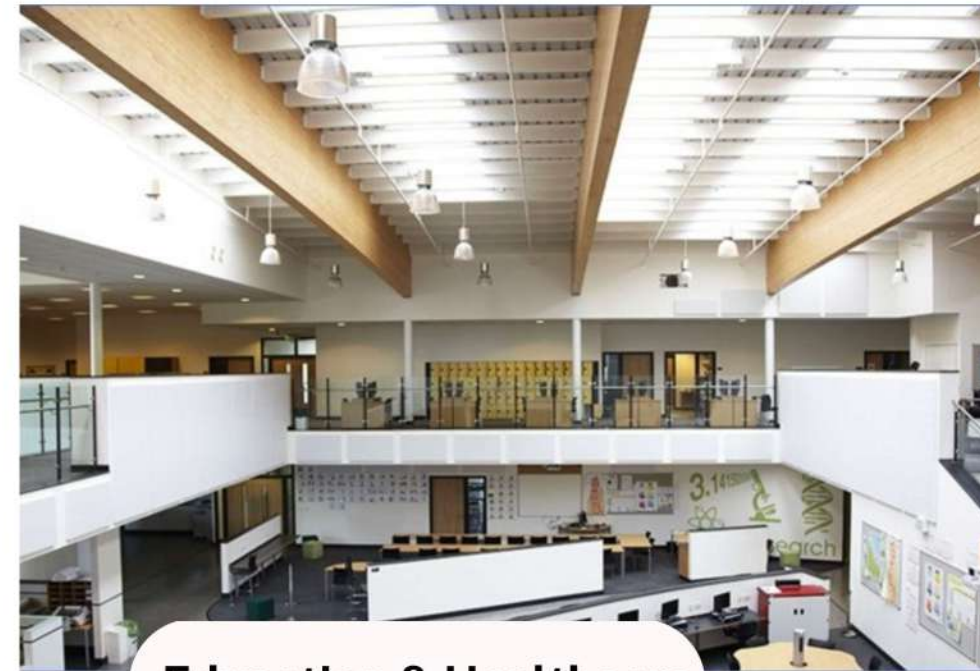

Education & Healthcare

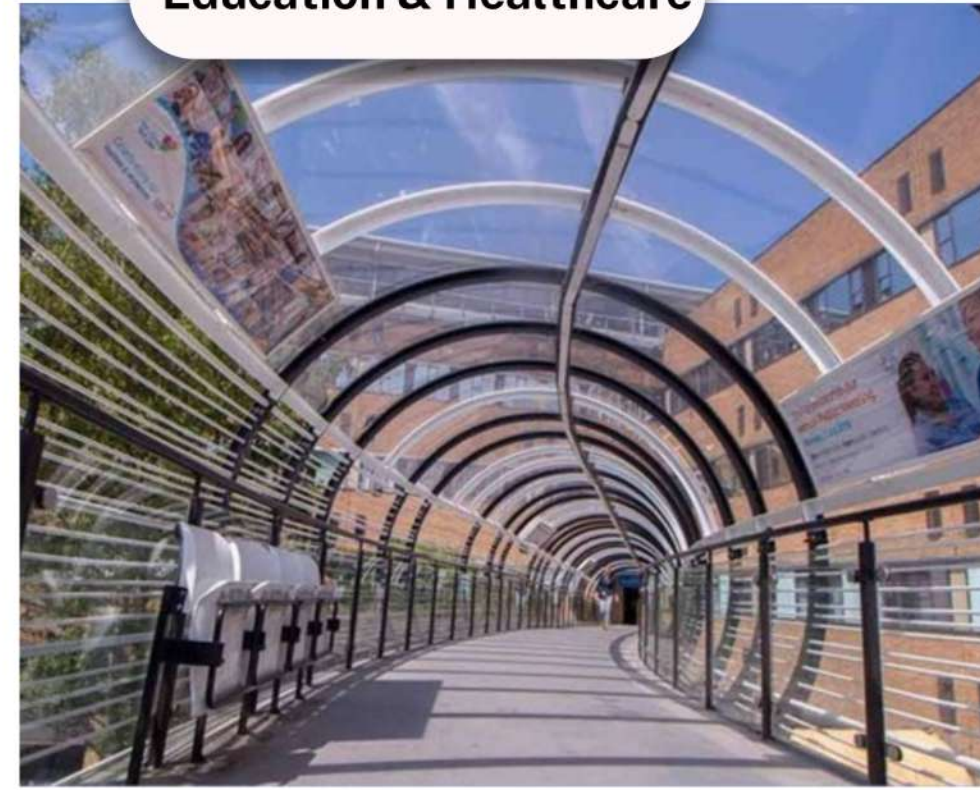

Daylight Systems With Brett Martin

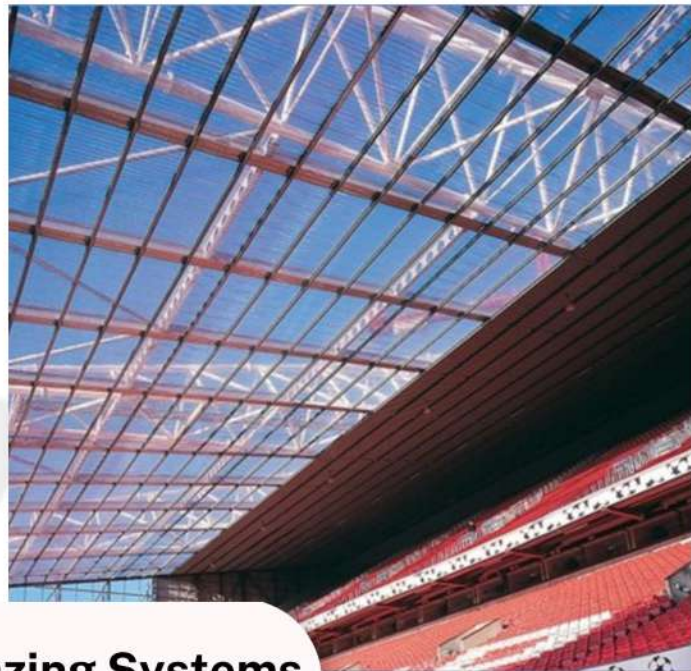

Architectural Glazing Systems

VENDOR APPROVAL



Nokia Al-Saudia

NOKIA Al-Saudia

Register as a supplier with Nokia Al-Saudia

Hello!

Khalid Alhewiti has invited you to register to become a supplier with Nokia Al-Saudia. Start by creating an account with Ariba Network. It's free.

Nokia Al-Saudia uses Ariba Network to manage its sourcing and procurement activities and to collaborate with suppliers. If MPCO already has an account with Ariba Network, sign in with your username and password.

[Click Here](#) to create account now

You are receiving this email because your customer, Nokia Al-Saudia, has identified you as the appropriate contact for this correspondence. If you are not the correct contact, please contact Nokia Al-Saudia.



Business Partner Code

Dear MODERN PLANNING CONTRACTING COMPANY LIMITED.

Your Business Partner Code is "LS-005467".
We look forward to your future collaboration on our projects.

NextGen a Nesma & Partners Initiative

Strategy and Business Transformation

Albawani



Registration with Albawani.

Congratulations! Albawani has approved your supplier registration. MODERN PLANNING CONTRACTING COMPANY LIMITED has now been included in the supplier database of Albawani.

You will be notified when next steps of the supplier onboarding process require your attention.

You are receiving this email because your customer, Albawani, has identified you as the appropriate contact for this correspondence. If you are not the correct contact, please contact Albawani.



Hello Zaid Abu Nsair,

Red Sea Global has approved the updates to Supplier registration questionnaire that aribasystem submitted on Thu, 28 Sep, 2023.

Best Regards,

SAP Ariba team

You are receiving this email because your customer, Red Sea Global, has identified you as the appropriate contact for this correspondence. If you are not the correct contact, please contact Red Sea Global.

Red Sea Global

SOME APPROVAL SAMPLES



Programme: King Abdullah Financial District (KAFFD)
Observation & Comments Sheet (OCS)

PROJECT / PARCEL	KAFD - P2-14	PROGRAMME No.	KAFD00214
OCS NUMBER	KAFD-A2-214-DAH-DCM-OCS-13739	DATE	29-Mar-22
ORIGINATOR	AL BAWANI CO. LTD.	TRANSMITTAL No. / DATE	P214-ABC-WTRAN-001332
DOCUMENT No.	KAFD-A2-214-ABC-STL-MAR-00003	DISCIPLINE	STL
DOCUMENT TITLE	Steel Structural of Skywalk Opening (Manufacturer: Gable Saudi Sub, Supplier: Modern Planning)	DOCUMENT TYPE	MAR

No.	Initial	Page / Section / Sheet	Comment Code	Reviewer Comment	Reply Code	Originator Reply	Reply Status by Reviewer
1	MM	GEN		Final Approval subject to :			
2	MM	GEN	1	All Works should be complied with the all requirements of Approved Struct & Facade & ARCH shop drawings and specifications .			
3	MM	GEN	1	Approved Intumescent paint with 120 minutes fire rating should be applied to steel structure and metal deck to meet the code requirements.			
4	MM	GEN	1	All measures and precautions to avoid any damages for the existing structures.			
5	MM	GEN	1	The Contractor should responsible for the design and safety of the system with respect of materials, erection and maintain the proper joining and dismantling.			
6	MM	GEN	1	The warranty should be submitted by the Applicator in compliance with the Project Specification.			
7	MM	GEN	1	WIR and MIR to be submitted as required			
8	MM	GEN	1	Contractor to respect any instructions shall issue by DAH engineers in relation of Application of this material.			

Review Status Code: **B**

Supervision Consultant (SC)	Project Management-Construction Management (PMCM)	Development and Management Company (KAFD-DMC)	Originator
Comments / Status Recommended by SC	Comments / Status Recommended by PMCM	Comments / Status Advised by KAFD-DMC	Reply Approved by
Name: Spiridon Mitri	Name: Francis Dougan	Name:	Name:
Position: Project Director	Position: Program Director	Position:	Position:
Signature:	Signature:	Signature:	Signature:
Date: 29-Mar-2022	Date:	Date:	Date:

Approval or No Objection status from the Reviewer shall be deemed as permission to proceed and shall not constitute acceptance or approval of design details, calculations, analyses, test methods, or materials developed or selected by the Originator and shall not relieve him from full compliance with contract technical specifications and drawings.

Programme: King Abdullah Financial District (KAFFD)
Observation & Comments Sheet (OCS)

PROJECT / PARCEL	KAFD - P2-14	PROGRAMME No.	KAFD00214
OCS NUMBER	KAFD-A2-214-DAH-DCM-OCS-13327	DATE	15-Mar-22
ORIGINATOR	AL BAWANI CO. LTD.	TRANSMITTAL No. / DATE	P214-ABC-WTRAN-001272
DOCUMENT No.	KAFD-A2-214-ABC-STL-POD-00002	DISCIPLINE	STL
DOCUMENT TITLE	PRE-QUALIFICATION DOCUMENTS OF MODERN PLANNING FACADE OPENING STEEL STRUCTURAL	DOCUMENT TYPE	PGD

No.	Initial	Page / Section / Sheet	Comment Code	Reviewer Comment	Reply Code	Originator Reply	Reply Status by Reviewer
1	MM	GEN	1	PRE-QUALIFICATION DOCUMENTS OF MODERN PLANNING FACADE OPENING STEEL STRUCTURAL is not acceptable.		Noted	Closed
2	MM	GEN	1	Contractor to submit: All the legal certificates and documents. Details of the competent engineers / persons that will be assigned for the site. Approval of previous projects in local markets KSA implemented by the company Any additional documents that help in the evaluation.		Done	Closed
3	MM	GEN	1	Scope of work to be clarified.		Done	Closed
4	MM	GEN	1	Contractor to respect our comments on KAFD-A2-214-ABC-STL-RFI-00004 (Sky walk closure gap Cement board structural calculations.)			

Review Status Code: **B**

Supervision Consultant (SC)	Project Management-Construction Management (PMCM)	Development and Management Company (KAFD-DMC)	Originator
Comments / Status Recommended by SC	Comments / Status Recommended by PMCM	Comments / Status Advised by KAFD-DMC	Reply Approved by
Name: Spiridon Mitri	Name: Francis Dougan	Name:	Name:
Position: Project Director	Position: Program Director	Position:	Position:
Signature:	Signature:	Signature:	Signature:
Date: 15-Mar-22	Date:	Date:	Date:

Approval or No Objection status from the Reviewer shall be deemed as permission to proceed and shall not constitute acceptance or approval of design details, calculations, analyses, test methods, or materials developed or selected by the Originator and shall not relieve him from full compliance with contract technical specifications and drawings.

AC GC	ROYAL SAUDI AIRFORCE SAUDI BRITISH DEFENCE CO-OPERATION PROGRAMME KING FAISAL AIR ACADEMY (KFAA), AL-MAJMA'AH PRIME CONTRACTOR ACCOMMODATION PROJECT	
SUBMISSION FOR APPROVAL		
The attached submission has been made by the Contractor.		
Submission No.: S019 Subject: GRP Sheet Location : King Faisal Air Academy (KFAA), Al-Majma'ah		
Manufacturer : Brett Martin Address : 24 Roughfort Road Mallusk, BT36 4RB United Kingdom Tel. No.: 44-28-9084-9999 Fax. No.:	Suppliers : Modern Planning Contracting Company Ltd. Address : Abi Bakr As Siddiq Rd, Al Mursalat, Riyadh 12624 Kingdom of Saudi Arabia Tel. No.: +966 11 44 66610 Fax. No.:	
I propose that the above submission should be approved subject to comments below: Comments: Comply with Specification "as attached"		
Signed by: Arabian Castles for General Contracting Co. LLC Technical Department. Signature: Date: 20/06/22 Stamp:		
Arabian Castles for General Contracting Co. Technical Department will not give approval to the construction department until BAE Systems have approved the Contractor's submission by signing below The approval will not relieve the contractor from his responsibilities under the contract.		
Approved by BAE Systems: BAE SYSTEMS Signature: Date: 14/06/2022 Stamp:		

SOME APPROVAL SAMPLES

PARSONS FAITHFUL+GOULD **مدرسة الملك سلمان** **MBL**

SUBCONTRACTOR PREQUALIFICATION SUBMITTAL FORM

Submittal Ref.	KSP-MBL-RAC-COM-CIV-PQD-0575	Revision	00	Date	09-Oct-2023
Program	King Salman Park				
Project	CP04 – Royal Arts Complex (RAC)	Project No.	2022.0612006		
Client	King Salman Park Foundation (KSF)				
PMO	Saudi Arabian Parsons Ltd. (SAP)	Contractor	Modern Building Leaders (MBL)		
PMCM [1]	Faithful + Gould (FGS)	PMCM [2]	WSP Middle East (WSP)		

Discipline: Civil Architecture Mechanical Electrical Information Technology
 Landscape Others

Sub-Contractor / Supplier Details	Attachments	Y / N
Name: MODERN PLANNING CONTRACTING CO.	Chamber of Commerce Membership.	Y
Trade: steel supplier		
Location: Riyadh – Al Mursalat, Abi Baker As Siddiq Rd.	Municipality License	Y
Experience (Total No. of Years): 25	Other Licenses (Specify):	Y
Experience in KSA: 25		
Contact Name:		
Mobile Number: +966 55 657 2840		
Is the company certified against any quality standard? yes	Pre-Qualification Doc's (Specify):	Y
Is the company certified against any Health & Safety and Environment standard? yes		
Subcontractors / Supplier's Proposed Scope of Work in this project		
ALL STEEL WORK Steel structure works, including design, structural calculations, fabrication & installation. (Primary structures, light weight, medium weight & heavy weight). (All types of steel fabrication needs).		
Aluminium works, curtain walls and facades.		
Cladding works & Fit outs work, General contracting.		
Daylight Systems from Brett Martin of UK, products range for different needs.	Completion Certificates for Previous Projects	Y

Contractor Signatures & Stamp (Technical Director)		Ashraf Metwaly Atia	Date	09-Oct-2023
Discipline Engineer	QA/QC	HSE	MEP	Construction Manager

PMCM Manager's Comments:
 - Contractor to Ensure All Certificates & Legal Documents are Valid until scope of works is complete.
 Prequalification Approval does not approve specific materials. Materials Subject to Material Approval.
 Factory Visit to be Available Upon Request.

Status:
 A - Approved B - Approved as Noted C - Revise and Resubmit D - Rejected

Name	Signature	Date

Document No.: KSP-FIF-RAC-CMT-CIV-PQD-0018_00
 Subcontractor Prequalification Submittal Form No.: KSP-MBL-PM2-PMC-COM-FRM-0001|00 | 31-Aug-22
 Page 1 of 2

دار الرياض **DAR AL RIYADH**

Supervision and Management Services for King Faisal Air Academy Facilities Relocation and Construction Project, Majma'a

TRANSMITTAL FORM

TRANSMITTAL NO. DAR-RSA-TR-240104-01 Date: 04/01/2024

SUBJECT: Prequalification for Modern Planning Contracting Co. for Metal Cladding in LW44

From: Project Director Office
 Technical Office Director
 Project Controls Director
 Quality Management Director
 HSE Director
 Finance and Contract Director
 Documents Control Director
 Construction Management Director

To: RSAF
 KFAA
 Nesma Partners JV "Al Habani ATS"
 Al Bawani, Shihb Al Jazira Salini Impregilo
 BAE Systems
 Other

Cc:

WE ARE SENDING Y Attached Under Separate Cover Via: the Following Items:
 Drawings Documents Studies Samples Specifications
 Copyletter Changeorder Other:

#	Date	Copies	Description
1	04/01/2024	1	BSS-SB-0-GE00-DC-10730-R00 - BSS-0-GE00-CP069-0669-R00

WE ARE SENDING YOU FOR:
 For approval
 For review and comment
 As requested
 For information
 Other:

REMARKS: Approved by RSAF

SENDER'S NAME: Abdugader Mahmoud Waly Job Title: Project Director SIGNED: P.P. Date: 04/01/2024

Acknowledgement of Receipt (kindly acknowledge receipt and return this sheet to the sender)
 RECEIVED BY: Job Title: SIGNED: Date: 7-1-24

Disclaimer:
 1. This transmittal is intended for the subject and purpose indicated above only.
 2. Any information in this document shall not be binding nor comprising any changes in the contract document unless submitted and approved by KFAA through the appropriate documentation channel.

DAR-KFAA-QMS-DC-FRM-07-R00

دار الرياض **DAR AL RIYADH** **BSS**

King Faisal Air Academy Facilities Relocation and Construction Project, Majmaah

PREQUALIFICATION REVIEW SHEET

Client: RSAF Consultant: DAR AL RIYADH Contractor: BSS JV

Prequalification Document for: Prequalification for Modern Planning Contracting Co. for Metal Cladding in LW44.

CLASSIFICATION <input checked="" type="checkbox"/> MANUFACTURER <input checked="" type="checkbox"/> SUPPLIER ONLY <input type="checkbox"/> SUBCON/INSTALLER <input type="checkbox"/> DESIGNER <input type="checkbox"/> LABORATORY BLDG NO / FACILITY LW44 Submission Planned Date:	DISCIPLINE <input checked="" type="checkbox"/> ARCHITECTURE <input checked="" type="checkbox"/> INTERIOR DESIGN <input type="checkbox"/> CIVIL <input type="checkbox"/> STRUCTURAL <input type="checkbox"/> MECHANICAL <input type="checkbox"/> ELECTRICAL <input type="checkbox"/> TELECOM <input type="checkbox"/> LANDSCAPE <input type="checkbox"/> SURVEY <input type="checkbox"/> OTHER	REFERENCER BSS-0-GE00-CP069-0669-R00 PREQUALIFICATION SUBMITTAL: * New Submittal Re-submittal SPECS. REFERENCE: Section 05092
--	---	---

BOQ ITEM REF: PHASE NO:

Proposed Manufacturer / Supplier / Installer:

COMPANY NAME	CONTACT PERSON	CONTACT NUMBER
Modern Planning Contracting Co.		+966 5567 2840

SUBMITTAL MANDATORY ATTACHMENT CHECKLIST (Contractor to check & verify all legal documents are valid & latest)

<input checked="" type="checkbox"/> Company profile	<input type="checkbox"/> Chamber of Commerce	<input checked="" type="checkbox"/> Organizational Structure	<input type="checkbox"/> RSA: prequalification criteria
<input checked="" type="checkbox"/> Completed project list (scope related)	<input type="checkbox"/> GCS Certificate	<input type="checkbox"/> Manpower & "each & skill staff"	<input type="checkbox"/> Machinery & Equipments
<input checked="" type="checkbox"/> Commercial Reg. (Commerce & Investment)	<input type="checkbox"/> Zakat & Tax Certificate	<input checked="" type="checkbox"/> Completed project list (scope related)	<input type="checkbox"/> SCE Certificate
<input checked="" type="checkbox"/> Saudi Contractors Authority (SCA) Certificate	<input checked="" type="checkbox"/> VAT Certificate	<input type="checkbox"/> List of Current projects	<input type="checkbox"/> Non Disclosure Agreement: Certificate
<input type="checkbox"/> Saudization Certificate	<input type="checkbox"/> ISO Certificate	<input checked="" type="checkbox"/> Mfg. Production capacity	<input type="checkbox"/> Mfg-Installer/Supplier Accred. Certificate

FACTORY VISIT Required Not Required Conflict of interest disclosure Prev. client informed consent

We certify that the above submitted documents have been reviewed in detail and are correct and conform with the contract requirements

Submitted by: Nabeeb Fahem Contractor Representative Signature: 28-Nov-2023 Date

DAR RECOMMENDATION

<input type="checkbox"/> A- Approved	Construction / fabrication / installation may be undertaken
<input checked="" type="checkbox"/> B- Approved as noted	Approval does not authorize changes in the contract sum or contract time
<input type="checkbox"/> C- Revise and Resubmit	Construction / fabrication / installation may not be undertaken
<input type="checkbox"/> D- Rejected	In resubmitting, limit revisions to the items marked

Approval shall not release Contractor of its liabilities under the Contract or constitute authorization of any change to Contract Documents.

Summary Comments:

Dar Al Riyadh (refer to attached for detailed comments)

Finance and Contracts Director
 Name: Mohammed Gineed-Ghaidi Signature: Date:

Project Director
 Name: Abdugader Mahmoud Waly Signature: P.P. Date:

Final Approval Status
 Approved
 Rejected

Quality Assurance
 Name: Signature: Date:

Project Directorate of KFAA Majmaah
 Name: Colonel Nassar Khalid Al-Otaibi Signature: Date: 9-01-24

Technical Quality Manual & ITP Sent upon request

VALUED CLIENTS



CONTACT US



Mob: +966556572840 / +966550502148
Tel: +966 11 44 66610



www.mpc-sa.com



info@mpco-sa.com
steel@mpco-sa.com



Abi Bakr As Siddiq Rd, Al Mursalat Riyadh 12464

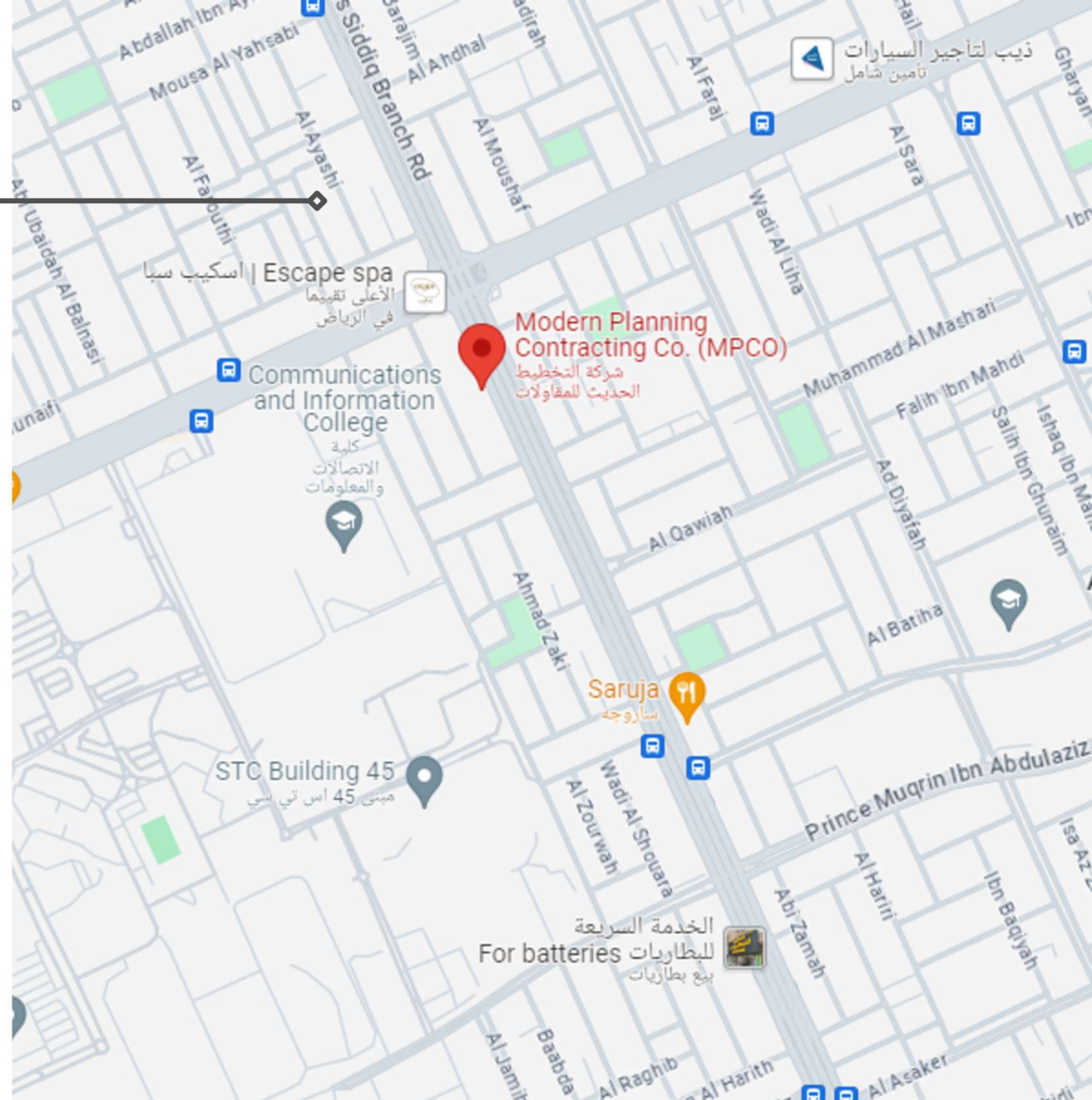



THANK YOU

www.mpcos-sa.com
